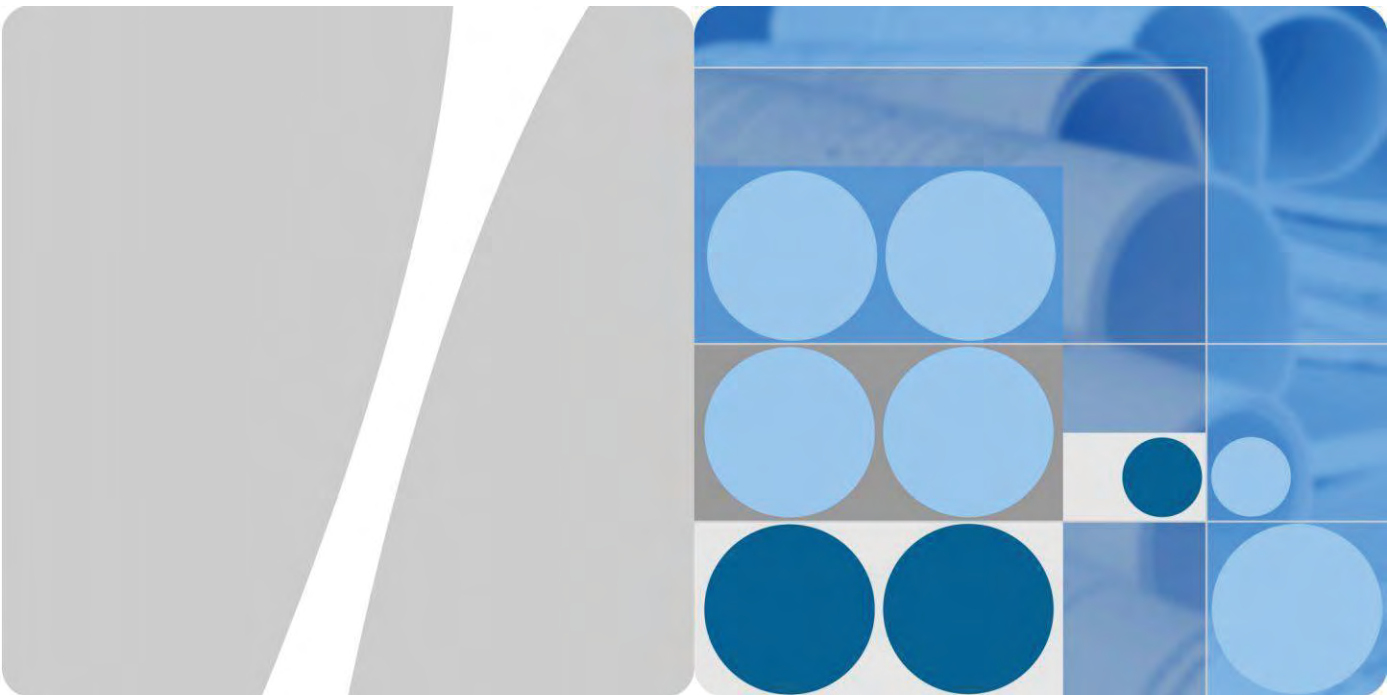




日揚國際事業股份有限公司
JD Auspice Co., Ltd.

SUN2000 (8KTL-28KTL) User Manual



note: subject to change without any notice, JDA pay no responsibility



Copyright © JD Auspice Co., Ltd 2015. All rights reserved.

No part of this document may be reproduced or transmitted in any form or by any means without prior written consent of JD AUSPICE Co., Ltd.

Trademarks and Permissions

All other trademarks and trade names mentioned in this document are the property of their respective holders.

Notice

The purchased products, services and features are stipulated by the contract made between JDA and the customer. All or part of the products, services and features described in this document may not be within the purchase scope or the usage scope. Unless otherwise specified in the contract, all statements, information, and recommendations in this document are provided "AS IS" without warranties, guarantees or representations of any kind, either express or implied.

The information in this document is subject to change without notice. Every effort has been made in the preparation of this document to ensure accuracy of the contents, but all statements, information, and recommendations in this document do not constitute a warranty of any kind, express or implied.



About This Document

Purpose

This document describes the SUN2000 in terms of its installation, electrical connections, commissioning, maintenance, and troubleshooting. Get familiar with this document before installing and operating the SUN2000.






This document is under continuous updates and correcting. You can download the latest version from <http://www.jdauspice.com>

Intended Audience

This document is intended for photovoltaic (PV) plant operators and qualified electrical technical personnel.

Symbol Conventions

The symbols that may be found in this document are defined as follows.

Symbol	Description
 CAUTION	Indicates an imminently hazardous situation which, if not avoided, will result in death or serious injury.
 WARNING	Indicates a potentially hazardous situation which, if not avoided, could result in death or serious injury.
 DANGER	Indicates a potentially hazardous situation which, if not avoided, may result in minor or moderate injury.
 NOTICE	Indicates a potentially hazardous situation which, if not avoided, could result in equipment damage, data loss, performance deterioration, or unanticipated results. NOTICE is used to address practices not related to personal injury.
 NOTE	Calls attention to important information, best practices and tips. NOTE is used to address information not related to personal



Symbol	Description
	injury, equipment damage, and environment deterioration.

Change History

Changes between document issues are cumulative. The latest document issue contains all the changes made in earlier issues.

Issue 07 (2014-07-30)

Added [4.5 Support-mounting the SUN2000](#).

Supplemented AC power cable specifications and models.

Modified the start time of the warranty period.

Issue 06 (2014-06-05)

Added more precautions for **Installation** and **Maintenance and Replacement** in [1 Safety Precautions](#).

Added [3 Inverter Storage](#).

Added more maintenance items in [8.2 Daily Maintenance](#).

Added [B Power Grid Standard Codes](#).

Issue 05 (2014-03-25)

Added cable types and precautions for cable connections in [5.3 Installing DC Input Power Cables](#).

Modified the output power of the inverter at different temperatures in **General Data** in [10 Technical Specifications](#).

Issue 04 (2013-12-15)

Added descriptions about the SUN2000-23KTL.

Issue 03 (2013-10-11)

Added descriptions about the SUN2000-28KTL.

Issue 02 (2013-06-08)

This issue is the second official release.

Issue 01 (2013-04-26)

This issue is the first official release.



Contents

About This Document	ii
1 Safety Precautions	1
2 Overview	3
2.1 Introduction	3
2.2 Appearance	5
2.3 Symbol Conventions	8
2.4 Monitoring Panel	11
2.5 Working Principles	14
3 Inverter Storage	19
4 Installation	20
4.1 Checking Before Installation	20
4.2 Tools	22
4.3 Determining the Installation Position	24
4.4 Moving the SUN2000	27
4.5 Support-mounting the SUN2000	28
4.6 Wall-mounting the SUN2000	33
5 Electrical Connections	42
5.1 Installing PGND Cables	42
5.2 Connecting AC Output Power Cables	45
5.3 Installing DC Input Power Cables	51
5.4 Connecting Communications Cables	57
5.4.1 Communications Port Description	57
5.4.2 Connecting RS485 Communications Cables	59
6 System Operation	64
6.1 Checking Before Power-On	64
6.2 Powering on the SUN2000	64
6.3 Setting Initialization Parameters	65
7 LCD	68
7.1 Monitoring Menu Hierarchy	68
7.2 Monitoring Operations	71



SUN2000 (8KTL-28KTL) User Manual	Contents
7.2.1 Viewing System Operating Information	71
7.2.2 Viewing Alarm Records	77
7.2.3 Setting System Time Parameters	79
7.2.4 Setting the System Language.....	81
7.2.5 Setting the Contrast.....	83
7.2.6 Setting the Currency and Currency Factor	85
7.2.7 Changing a Password.....	87
7.2.8 Setting Communications Parameters.....	89
7.2.9 Setting Protection Parameters	91
7.2.10 Setting Feature Parameters	93
7.2.11 Setting Isolation Parameters	95
7.2.12 Enabling Manual Power-On and Power-Off	96
7.2.13 Restoring Factory Settings.....	99
7.2.14 Cleaning the User Data.....	101
7.2.15 Enabling the USB Guide Function	102
7.2.16 Viewing the System Version.....	105
8 Maintenance	107
8.1 Powering Off the SUN2000.....	107
8.2 Daily Maintenance.....	108
8.3 Common Faults and Troubleshooting Measures	108
9 Invert er-Associated Operations	115
9.1 Removing the SUN2000	115
9.2 Packing the SUN2000.....	115
9.3 Disposing the SUN2000	115
10 Technical Specifications	116
11 Quality Assurance	120
A Abbreviation	121
B Power Grid Standard Codes	122



1 Safety Precautions

Read the safety precautions carefully to ensure human safety.

Personnel Requirements

- Only qualified and trained electrical technicians are allowed to operate the SUN2000.
- Operation personnel should understand the composition and working principles of the PV grid-tied power system and local regulations.

Identification Protection

- The signs on the SUN2000 shell specify important information about secure operation. Do not damage the signs.
- The nameplate attached to the SUN2000 side panel lists the SUN2000 parameter information. Do not damage the nameplate.

Installation



NOTICE

Before installation, read this document carefully. JDA shall not be liable for any consequence caused by violation of the regulations specified in this document.

- Before installing the SUN2000, ensure that the SUN2000 is not connected or electrified.
- To ensure good heat dissipation and reserve enough space for installing the SUN2000, the SUN2000 is at least 200 mm, 500 mm, 600 mm, and 1000 mm away from objects on its both sides, top, bottom, and front respectively.
- Install the SUN2000 in environments with good ventilation to ensure system performance.
- Ensure that the SUN2000 heat sinks are unblocked.
- Do not move the components inside the shelf except the wiring terminals at the bottom.



Before connecting cables to the SUN2000, ensure that the SUN2000 is intact and secure. Otherwise, electrical shocks or fire may be triggered.

-
- Before connecting cables to the SUN2000, shield the PV modules by using opaque cloth.
 - All electrical connections must comply with local laws and regulations.
 - Before using the SUN2000 to generate electricity in grid-tied mode, obtain approval from the local power supply department.
 - Ensure that the cables to the solar power system are properly connected and insulated (That is, the insulation resistance between the ground and the main loop formed by PV module strings, the SUN2000, and protective devices is less than 1 Mohm.) and meet specifications.

Operation

High voltages may cause electrical shocks and death during SUN2000 operation. Strictly comply with the safety precautions in this document and associated documents when operating the SUN2000.

-
- Do not disconnect the DC power supply during the SUN2000 operation.
 - Do not touch a running SUN2000 except for the liquid crystal display (LCD) and DC switch because the shelf and heat sinks become hot during the SUN2000 operation.
 - Only professionals are allowed to set initialization parameters during the first power-on of the SUN2000. Incorrect settings may affect the SUN2000 operation and cause the SUN2000 to conflict with local certification.
 - Keep an over 20 cm distance away from the SUN2000 because radiation is generated during the SUN2000 operation.
 - When operating the SUN2000, follow local laws and regulations.

Maintenance and Replacement

- Before any maintenance, power off the SUN2000 based on the power-off guidelines and then wait for at least 5 minutes.
- Stand temporary warning signs or fences to prevent unauthorized personnel to enter the maintenance site.
- Rectify the faults that compromise the SUN2000 security performance before restarting the SUN2000.
- A faulty SUN2000 requires overall maintenance. Contact the dealer if any fault occurs inside the SUN2000.
- Maintain the SUN2000 after you get familiar with this document and tools and testing equipment are prepared.
- When maintaining the SUN2000, wear ESD gloves and comply with ESD precautions.

2 Overview

This topic describes the SUN2000 in terms of its functions, network application, appearance, and working principles.

2.1 Introduction

Introduction of the function, model and application of the SUN2000.

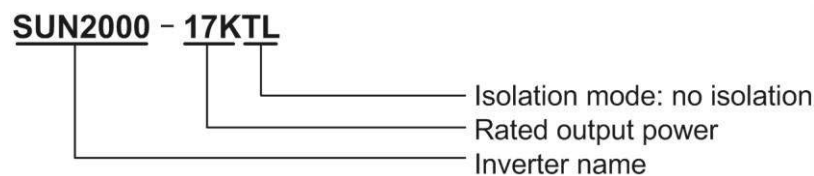
Function

The SUN2000 is a grid-tied PV inverter. It converts the high-voltage DC power generated by PV arrays into sine wave three-phase AC power with the same frequency and phase as the power grid.

Model

[Figure 2-1](#) shows the model composition of the SUN2000, taking SUN2000-17KTL as an example.

Figure 2-1 Model description



[Table 2-1](#) lists all models of the SUN2000 and their rated output power.

Table 2-1 SUN2000 models and rated output power

Model	Rated Output Power
SUN2000-8KTL	8 kW
SUN2000-10KTL	10 kW

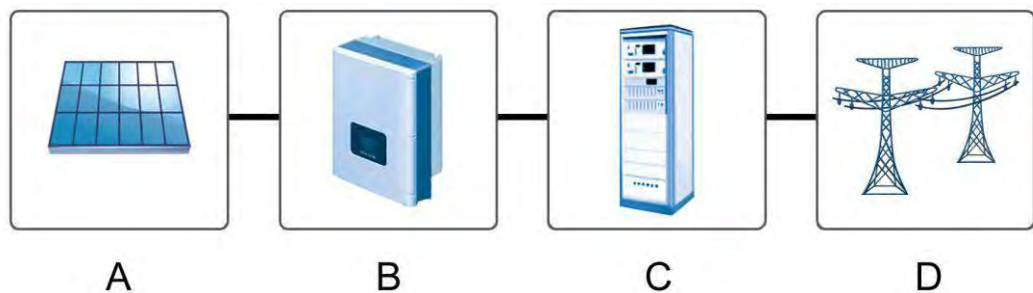


Model	Rated Output Power
SUN2000-12KTL	12 kW
SUN2000-15KTL	15 kW
SUN2000-17KTL	17 kW
SUN2000-20KTL	20 kW
SUN2000-23KTL	23 kW
SUN2000-28KTL	27.5 kW

Application

The SUN2000 applies to commercial rooftop grid-tied systems and large power station grid-tied systems. Typically, the grid-tied system consists of PV modules, grid-tied inverters, and AC distribution modules (ACDUs), as shown in [Figure 2-2](#).

Figure 2-2 SUN2000 application



A. PV array	B. SUN2000
C. ACDU	D. Power grid

Power Grid Modes for the SUN2000

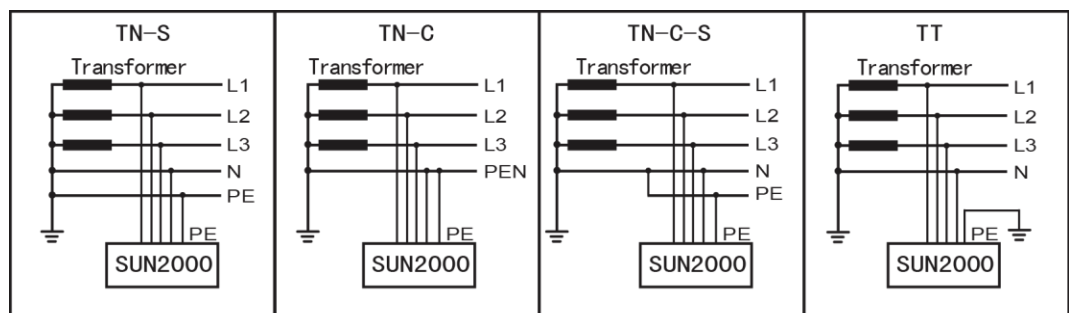
The SUN2000-8KTL to SUN2000-23KTL support the following power grid modes: TN-S, TN-C, TN-C-S, and TT, as shown in [Figure 2-3](#). The SUN2000-28KTL supports the IT mode, as shown in [Figure 2-4](#).



NOTICE

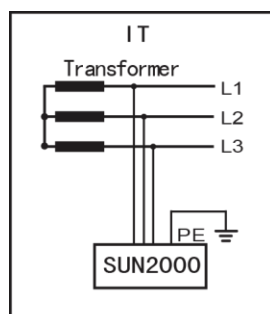
- For TT grid mode, the valid value of the neutral-ground voltage should be less than 20 V.
- The SUN2000-28KTL applies to the medium-voltage grids and has three-phase, three-wire outputs.

Figure 2-3 Power grid modes supported by the SUN2000-8KTL to SUN2000-23KTL



IS01SC0004

Figure 2-4 Power grid modes supported by the SUN2000-28KTL

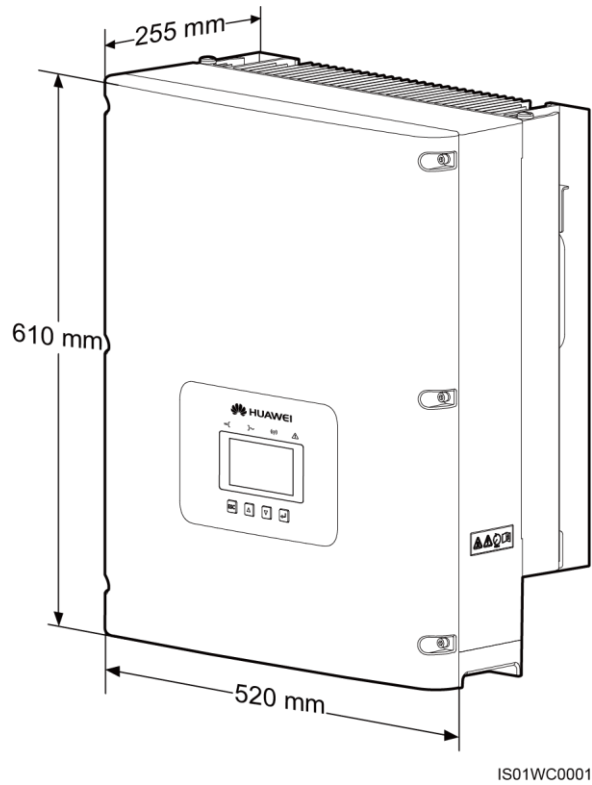


IS01SC0005

2.2 Appearance

This topic describes the SUN2000 in terms of its appearance and specifications.

Front view



1. Shell

2. Control panel

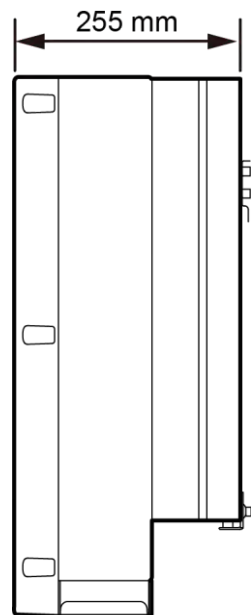


NOTE

The LCD displays the SUN2000 operating data, such as input power, output power, and electricity output. The indicators show the SUN2000 operating status and its faults.

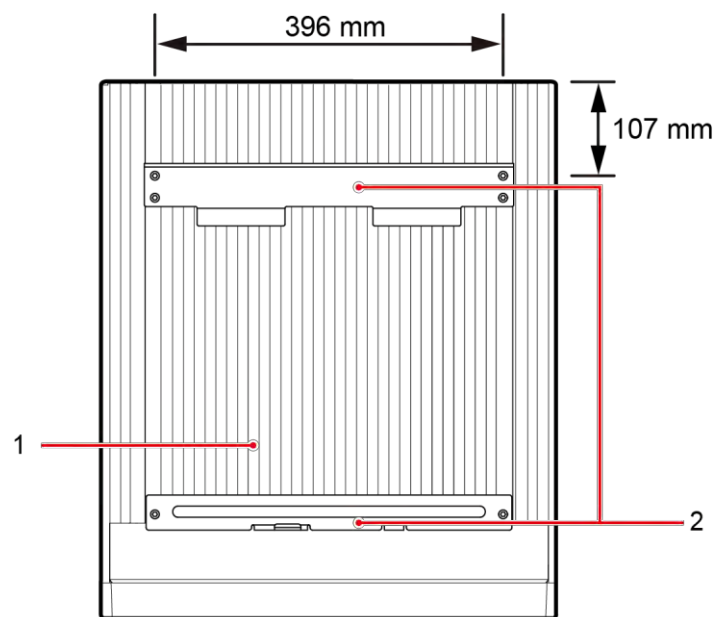


Side view



IS01WC0002

Rear view

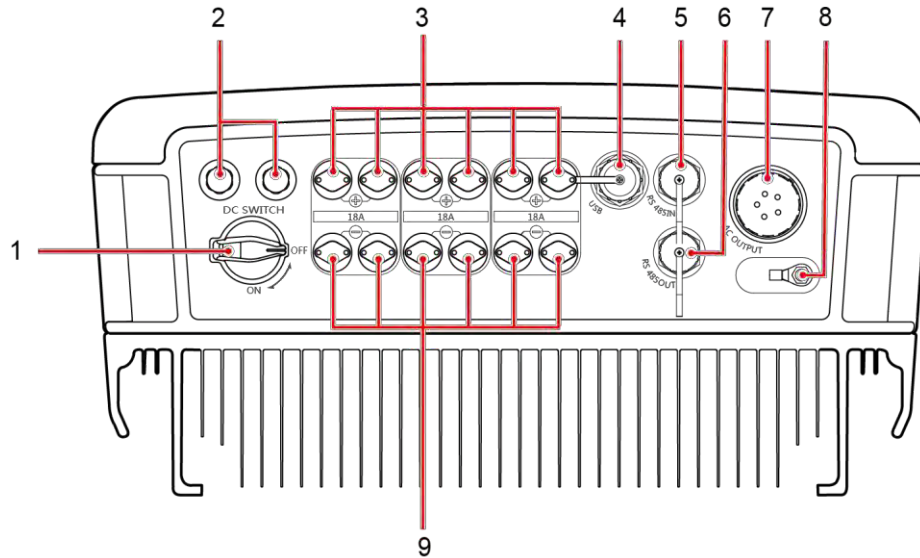


IS01WC0003

1. Heat sink

2. Install mounting rackets

Bottom view



IS01WC0004

- 1. DC switch
- 2. Ventilation valves
- 3. DC input port (positive)
 Note: The objects in blue are dustproof plugs. Remove them before connecting DC input power cables.
- 4. USB port
- 5. RS485 IN port
- 6. RS485 OUT port
- 7. AC output port
- 8. Ground bolt
- 9. DC input port (negative)
 Note: The objects in blue are dustproof plugs. Remove them before connecting DC input power cables.


2.3 Symbol Conventions

Introduction of the symbols and nameplates of the SUN2000.





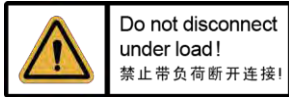



Symbol

Table 2-2 describes all symbols on the SUN2000.

Table 2-2 Symbols

Symbol	Name	Meaning
	Danger high voltage label	The SUN2000 operates at high voltages. All operation on the SUN2000 may only be carried out by a trained electrically skilled person.



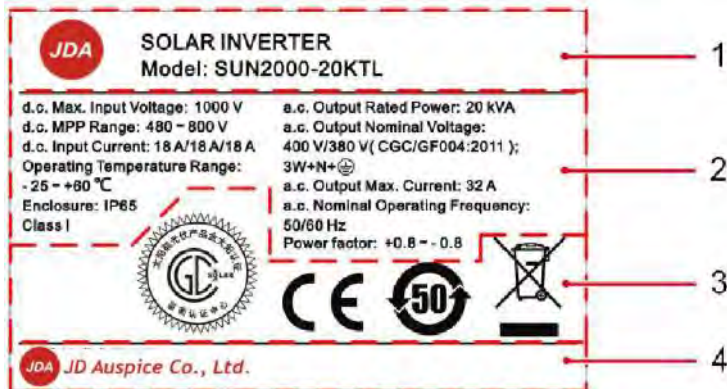
Symbol	Name	Meaning
	Delay discharge label	There is residual voltage in the SUN2000. The SUN2000 needs 5 minutes to electrically discharge.
	High temperature label	Do not touch a running SUN2000 because it generates high temperatures on the shell.
	Refer to the instructions label	Remind operators to refer to the documents shipped with the SUN2000.
	Grounding label	Connect the SUN2000 to a ground bar for grounding purposes.
	Operation warning label	Do not remove the DC input connector when the SUN2000 is running.
	CE certification label	This product complies with the Conformance Europeenne (CE) certification standards.
	CGC-Solar certification label	This document complies with CGC-Solar certification standards.
	EU waste electrical and electronic equipment (WEEE) label	Do not dispose the SUN2000 as household garbage. For details about how to dispose the SUN2000, see 9 Inverter-Associated Operations .

Identifying Nameplates

Each SUN2000 is labeled with a nameplate on which you can view the model, technical specifications, and certification label, as shown in [Figure 2-5](#).



Figure 2-5 Nameplates



1. Trademark and product model of the SUN2000	2. Technical specifications of the SUN2000
3. Labels of certifications that the SUN2000 complies with	4. Company name and the manufacturing place

Table 2-3 describes certification labels.

Table 2-3 Certification labels

Label	Label Name	Meaning
	CGC-Solar certification label	This document complies with CGC-Solar certification standards. Note: The SUN2000-8KTL, SUN2000-10KTL, and SUN2000-12KTL have no this label.
	Conformite Europeenne (CE) certification label	This product complies with the CE certification standards.
	Environmentally friendly use period (EFUP) label	This product does not pollute the environment during a specified period.
	EU waste electrical and electronic equipment (WEEE) label	Do not dispose the SUN2000 as household garbage.

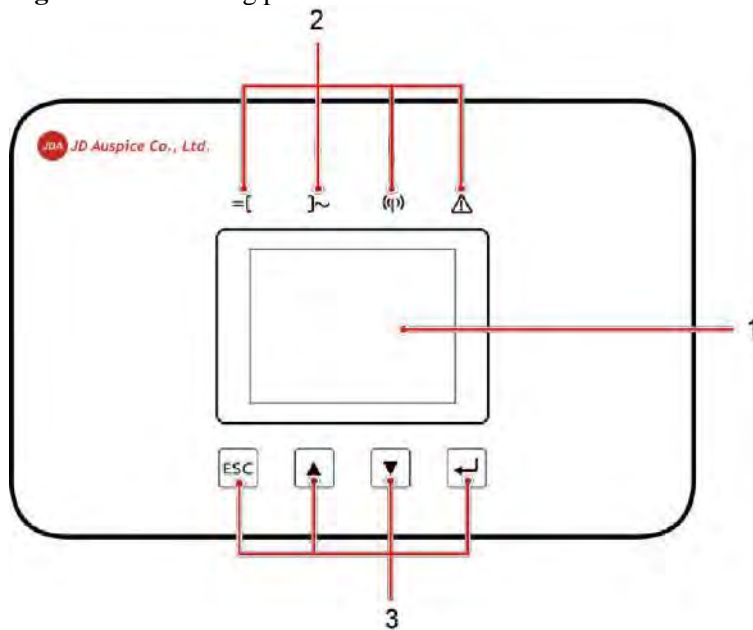
2.4 Monitoring Panel

This topic describes the appearance of the monitoring panel, including an LCD, indicators, and buttons.

Monitoring panel

The monitoring panel provides one LCD, four indicators, and four buttons, as shown in [Figure 2-6](#).

Figure 2-6 Monitoring panel



1. LCD

2. Indicators

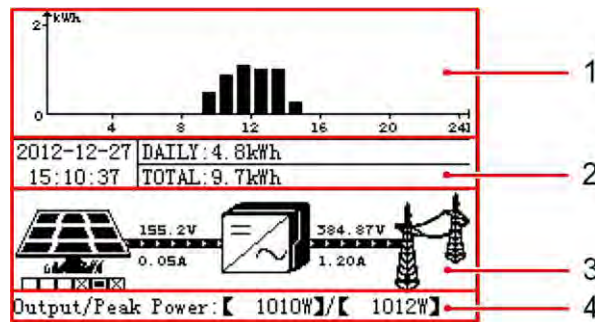
3. Buttons

LCD

The LCD displays the SUN2000 data in graphics and characters, including the operating information, alarm information, system parameters, and user parameters.

If you do not press any button within 90s, the liquid crystal display (LCD) returns to the default page automatically, as shown in [Figure 2-7](#).

Figure 2-7 Default page

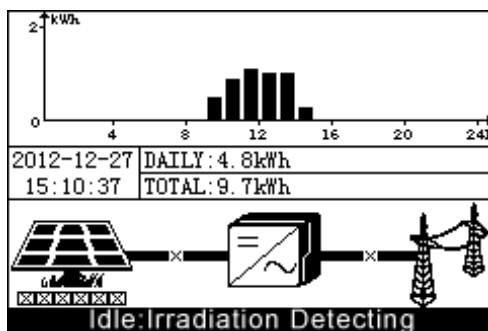


(1) Energy yield histogram	Allows you to view the energy yield data within 24 hours.
(2) Energy yield data	<ul style="list-style-type: none"> • Allows you to view the date and time. • Allows you to view the general energy yield data from 0:00 to the current time. • Allows you to view the total energy yield data from the startup time to the current time.
(3) Power flow diagram	<ul style="list-style-type: none"> • Allows you to view the number of PV string inputs. The six boxes under the PV module stand for the number of PV string inputs. where <ul style="list-style-type: none"> – The box filled with a cross indicates that the corresponding PV string is not connected or its power is low. – The box filled with white or black indicates that the corresponding PV string works properly. • Allows you to view the power flow from the PV strings to the SUN2000 and view the voltage and current of each input. • Allows you to view the power flow from the SUN2000 to the power grid and view the voltage and current of each output. <ul style="list-style-type: none"> – For the SUN2000-8KTL to SUN2000-23KTL, displays the effective values of the phase voltage and phase current of the SUN2000 three-phase output. – For the SUN2000-24.5KTL, and SUN2000-28KTL, displays the effective values of the line voltage and line current. <p>NOTE The system displays the voltage and current of the route corresponding to the box filled with black and switches between the connected PV strings every 10 seconds.</p>
(4) Output/Peak power	Allows you to view the output power and peak power of the SUN2000.

- Figure 2-8 shows the displayed page when the sunlight does not meet the conditions for the startup of the SUN2000.

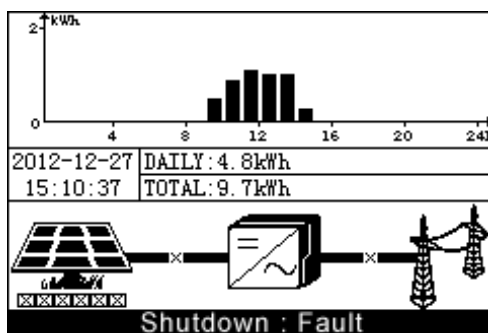


Figure 2-8 Idle: Irradiation Detecting



- [Figure 2-9](#) shows the displayed page when the SUN2000 detects a fault or a shutdown command.



Figure 2-9 Shutdown: Fault





Indicators

The SUN2000 monitoring panel provides four indicators, which are described in [Table 2-4](#).

Table 2-4 Indicator description

Indicator	State	Meaning
PV connection indicator 	Steady green	The SUN2000 connects to at least one of the PV arrays properly.
	Off	The SUN2000 disconnects from all PV arrays.
Feed in grid indicator 	Steady green	The SUN2000 connects to the power grid properly.
	Off	The SUN2000 disconnects from the power grid.
Wireless connection indicator	Reserved	Reserved.






Indicator	State	Meaning
		
Alarm indicator 	Steady red	The SUN2000 generates a major alarm. For details about the alarm, see 7.2.2 Viewing Alarm Records .
	Blinking red at short intervals (on for 0.5s and then off for 0.5s)	The SUN2000 generates a minor alarm. For details about the alarm, see 7.2.2 Viewing Alarm Records .
	Blinking red at long intervals (on for 1s and then off for 4s)	The inverter generates a warning. For details about the warning, see 7.2.2 Viewing Alarm Records .

Buttons

The SUN2000 monitoring panel has four buttons, which are described in [Table 2-5](#).

Table 2-5 Button description

Button	Name	Function
ESC	Return button	Allows you to return to the last page or end an operation.
	Cursor Up button	Allows you to go to the upper-level menu or set parameters.
	Cursor Down button	Allows you to go to the lower-level menu or set parameters.
	Confirm button	Allows you to go to the menu or confirm the value.



NOTE

The backlight lasts 60s after you press any button.

2.5 Working Principles

This topic describes the SUN2000 working principles.

Conceptual Diagrams

- The SUN2000-15KTL, SUN2000-17KTL, SUN2000-20KTL, SUN2000-23KTL, SUN2000-24.5KTL, and SUN2000-28KTL receive inputs from six PV strings. Then the

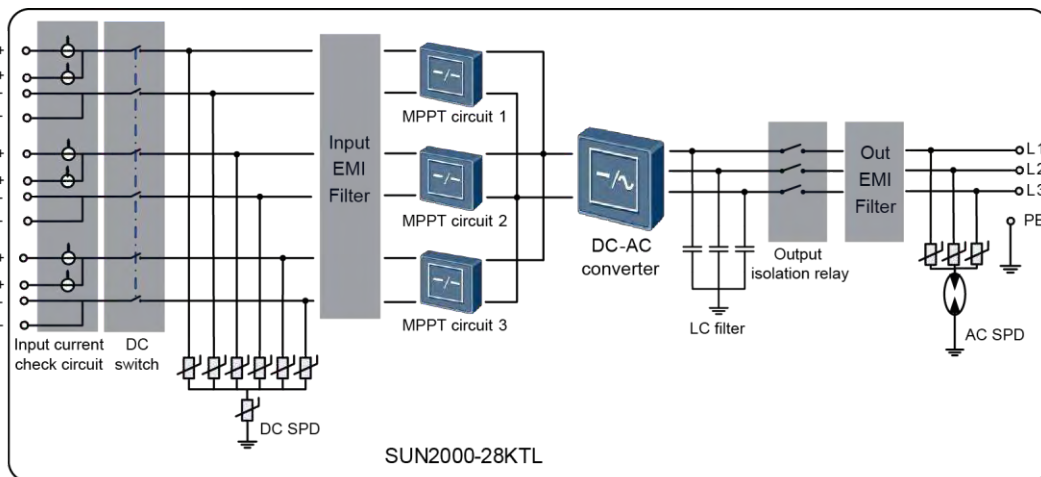


inputs are grouped into three MPPT routes inside the SUN2000 to track the maximum power point of the PV strings.

- The SUN2000-8KTL, SUN2000-10KTL, and SUN2000-12KTL receive inputs from four PV strings. Then the inputs are grouped into two MPPT routes inside the SUN2000 to track the maximum power point of the PV strings.

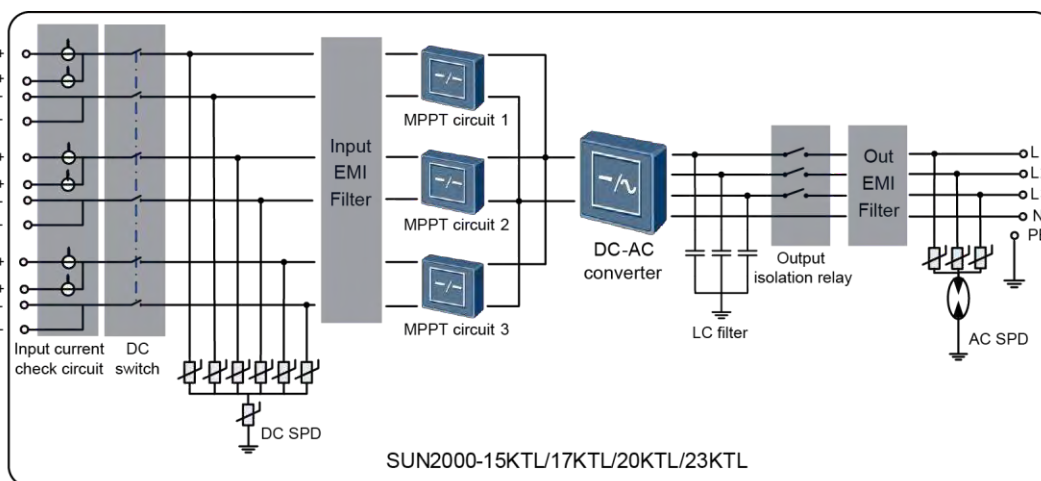
After that, the DC power is converted into three-phase AC power through an inverter circuit. Surge protection is supported on both the DC and AC sides. See [Figure 2-10](#), [Figure 2-11](#), and [Figure 2-12](#).

Figure 2-10 Conceptual diagram for the SUN2000-28KTL



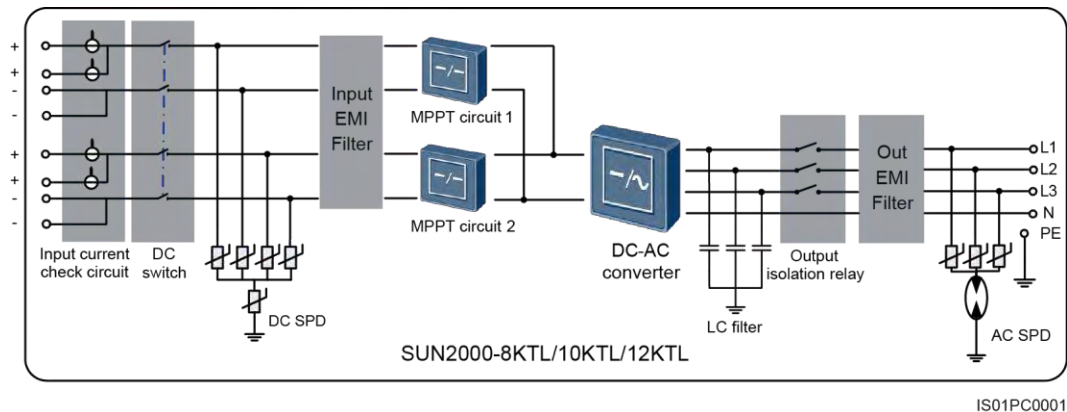
IS01PC0003

Figure 2-11 Conceptual diagram for the SUN2000-15KTL, SUN2000-17KTL, SUN2000-20KTL, and SUN2000-23KTL



IS01PC0002

Figure 2-12 Conceptual diagram for the SUN2000-8KTL, SUN2000-10KTL, and SUN2000-12KTL



The working principles of the SUN2000 are described as follows:

- The SUN2000 analyzes the operating status of each PV array over the input current measure circuit and generates an alarm to prompt maintenance if an exception occurs in a PV array.
- The DC switch disconnects internal circuits from the DC input to facilitate maintenance.
- The category II DC surge protection device (SPD) on the input side provides the discharge loop for the overvoltage power on the DC side to protect the SUN2000 internal circuits from DC overvoltage.
- The input and output electromagnetic interference (EMI) filters filter out the electromagnetic interference inside the SUN2000 to ensure that the SUN2000 meets electromagnetic compatibility requirements.
- The MPPT circuits ensure optimal output power by measuring the voltages and currents of PV arrays and tracking the MPP.
- The DC-AC conversion circuit converts DC power into AC power and then feeds the AC power to the power grid. The output frequency and voltage match the power grid.
- The LC filter filters out the high-frequency components from the output current of the SUN2000 to ensure that the output current meets power grid requirements.
- The output isolation relay isolates the inverter from the power grid if either of them is faulty.
- The category III AC SPD on the output side provides the discharge loop for the overvoltage power on the AC side to protect the SUN2000 internal circuits from AC overvoltage.

Working Modes

Figure 2-13 shows the conditions for the SUN2000 to switch between working modes.

Figure 2-13 Working modes

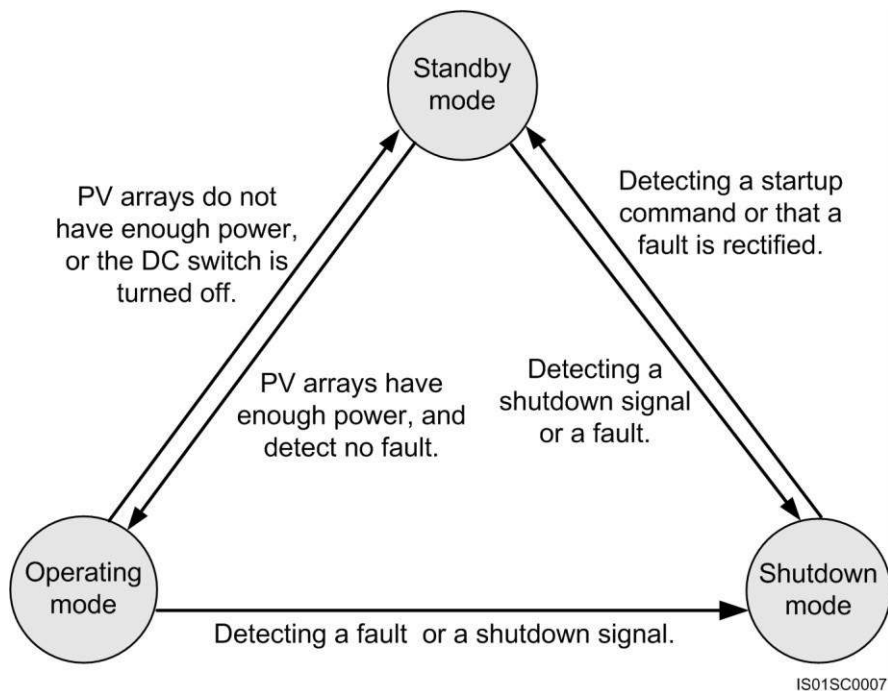


Figure 2-13 describes the operations shown in Table 2-6.

Table 2-6

Working Mode	Description
Standby	<p>The SUN2000 enters the standby mode when the external environment does not meet the requirements for starting the SUN2000. In standby mode, the SUN2000 continuously performs the self-check and enters the operating mode once the operation requirements are met.</p> <p>The standby mode involves four phases: initialization detection phase, insulation resistance detection phase, sunlight detection phase, and no sunlight phase.</p> <p>If the SUN2000 receives a shutdown command or detects a fault after startup in this mode, it enters the shutdown mode.</p>
Operating	<p>In operating mode,</p> <ul style="list-style-type: none"> • The SUN2000 converts DC power from PV strings into AC power and feeds the power to the power grid. • The SUN2000 always tracks the maximum power point to maximize the PV string output. • The SUN2000 enters the shutdown mode after detecting a fault or a shutdown command, and enters the standby mode after detecting that the PV string output power does not meet the requirements for grid-tied electricity generation.
Shutdown	<p>The SUN2000 enters the shutdown mode after detecting a fault or receiving</p>



Working Mode	Description
	<p>a shutdown command in standby or operating mode.</p> <p>The SUN2000 may shut down due to a fault, after receiving a shutdown command, or after manual operation.</p> <p>After detecting a startup command or that a fault is rectified, the SUN2000 enters the standby mode.</p>



3 InverterStorage

Closely read the following requirements for inverter storage:

The following requirements should be met if the inverter is not put into use directly:

- Do not unpack the inverter.
- Store the inverter at -40°C to $+70^{\circ}\text{C}$ and under humidity of 0 to 100% RH (non-condensing).
- A maximum of four inverters can be stacked.
- Periodic inspections are required during the storage. If any rodent bites are found, replace the packing materials immediately.
- If the inverter has been long-term stored, inspections and tests should be conducted by qualified personnel before it is put into use.



4 Installation

This topic describes how to install the SUN2000.

Context



DANGER

- Do not install the SUN2000 on flammable building materials.
 - Do not store the SUN2000 in areas with flammable or explosive materials.
-



WARNING

Do not install the SUN2000 in places prone to body contact because the SUN2000 shelf and heat sinks become hot during the SUN2000 operation.

4.1 Checking Before Installation

Before unpacking, check that the packing materials are intact. After unpacking, check that the deliverables are complete and intact.

Checking Outer Packing Materials

Check the outer packing materials for damage, such as holes and cracks. If any damage is found, do not unpack the SUN2000 and contact the dealer as soon as possible.

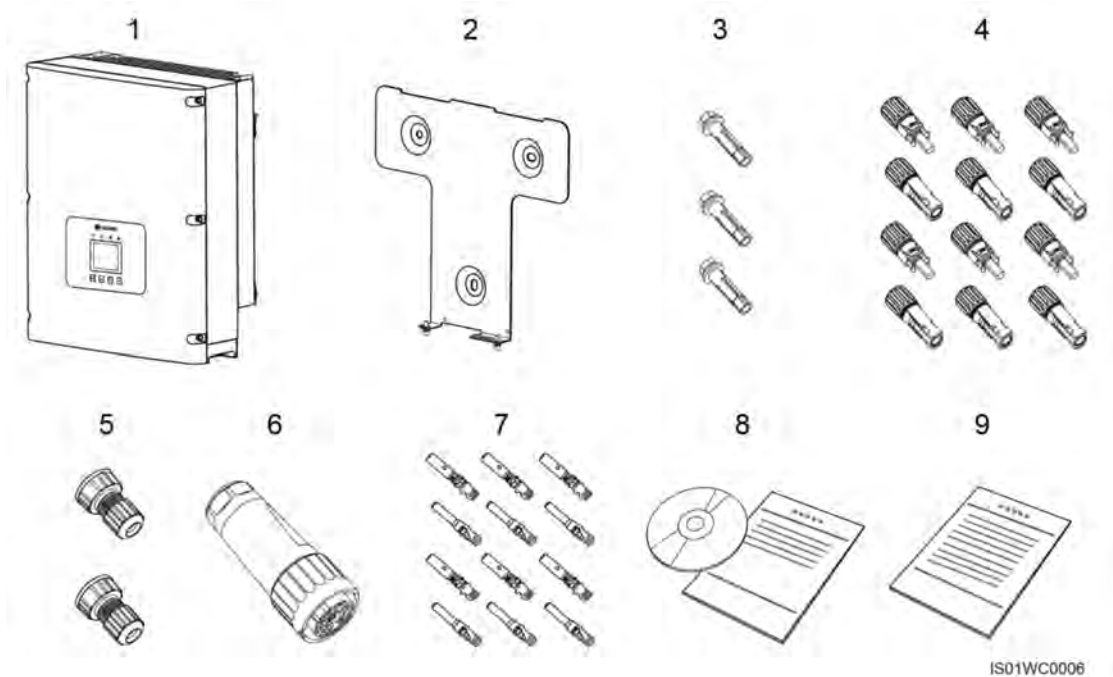
You are advised to remove the packing materials within 24 hours before installing the SUN2000.

Checking Deliverables

After unpacking the SUN2000, check whether deliverables are intact and complete. If any damage is found or any component is missing, contact the dealer.

Figure 4-1 shows the components and mechanical parts that should be delivered.

Figure 4-1 Deliverables



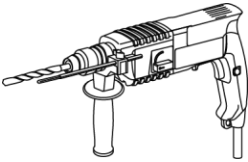



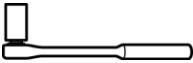
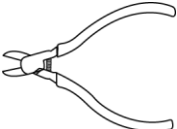
No.	Name	Quantity	Description
1	SUN2000	1	N/A
2	Rear panel	1	N/A
3	Expansion bolt	3	Secures the rear panel to a wall.
4	DC input connector	8/12	Connects to a DC input power cable. <ul style="list-style-type: none"> SUN2000-8KTL/10KTL/12KTL: 8 PCS (four positive connectors and four negative connectors) SUN2000-15KTL/17KTL/20KTL/23KTL/28KTL: 12 PCS (six positive connectors and six negative connectors)
5	Waterproof RJ45 connector	2	Connects to a communications cable.
6	AC output connector	1	Connects to an AC output power cable.
7	Metal terminal	8/12	Secures a connector to a DC input power cable. NOTICE



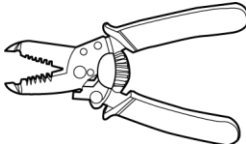
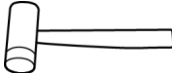


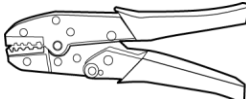
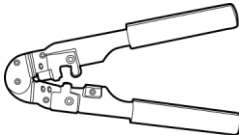


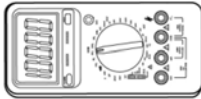
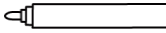
No.	Name	Quantity	Description
			Positive and negative metal terminals are packed with positive and negative connectors respectively. Separate the positive from negative metal terminals after unpacking the SUN2000 to avoid confusing the polarities.
8	Documentation	1	Includes the quick installation guide in paper copies and user manual in a CD-ROM.

4.2 Tools

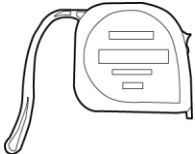

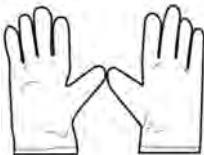


Prepare tools required for installation and electrical connections.

Tool	Model	Function
Hammer drill 	With a drill bit of $\Phi 14$	Drills holes on the wall
Adjustable wrench 	With an open end of larger than or equal to 32 mm	Tightens expansion bolts
Torque screwdriver 	<ul style="list-style-type: none"> Hexagon socket head: 5 mm Flat head: M6 	<ul style="list-style-type: none"> Hexagon socket head: Secures screws to mechanical parts Flat head: Removes plastic screws from lifting holes
Flat-head screwdriver 	3x100 <ul style="list-style-type: none"> Head width: 3-3.5 mm Pole length (excluding the handle): at least 100 mm Large handle 	<ul style="list-style-type: none"> Tightens or loosens screws when installing AC power cables Used to remove AC connectors from the SUN2000
Socket wrench 	With an open end of 10 mm	Tightens ground bolts.
Diagonal pliers 	-	Cut and tighten cable ties.



Tool	Model	Function
Wire stripper 	Applies to cables with cross-sectional areas of 4 mm ² , 6 mm ² , and 10 mm ²	Peels cable jackets.
Rubber mallet 	-	Hammers expansion bolts into holes.
Guarded blade utility knife 	-	Removes packages.
Cable cutter 	Applies to cables with cross-sectional areas of 4 mm ² , 6 mm ² , and 10 mm ²	Cuts power cables.
Crimping tools 	H4TC0001 Manufacturer: AMPHENOL	Crimps cables.
RJ11 crimping tool 	-	Prepares RJ45 connectors for communications cables.
Removal tool 	H4TW0001 Manufacturer: AMPHENOL	Removes DC connectors from the SUN2000.
Vacuum cleaner 	-	Cleans up dust after drilling holes.
Multimeter 	-	Checks the grounding connections.
Marker 	Diameter: 10 mm at most	Marks signs.



Tool	Model	Function
Measuring tape 	-	Measures distances.
Level 	-	Checks the levelness of the backplanes.
ESD gloves 	-	Protect your hands during installation.
Safety goggles 	-	Prevents dust from entering your mouth and nostrils during hole drilling.
Anti-dust respirator 	-	Prevents dust from entering your mouth and nostrils during hole drilling.

4.3 Determining the Installation Position

Determine an appropriate position for installing the SUN2000.

Comply with the following requirements when determining the installation position:



DANGER

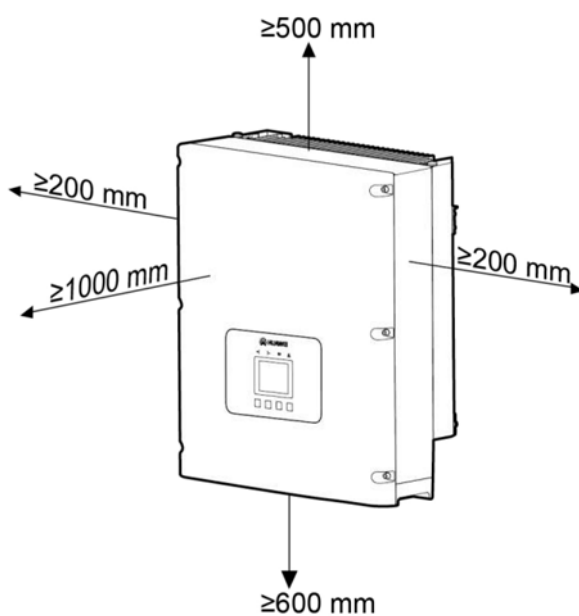
- Do not install the SUN2000 on flammable building materials.
- Do not store the SUN2000 in areas with flammable or explosive materials.

WARNING

Do not install the SUN2000 in places prone to body contact because the SUN2000 shelf and heat sinks become hot during the SUN2000 operation.

- The installation methods and position match the weight and dimensions of the SUN2000. For details, see [10 Technical Specifications](#).
- The wall is solid enough to bear the SUN2000.
- The cable connection area faces downwards.
- Install the SUN2000 vertically or lean it backward for at most 15 degrees.
- The SUN2000 is installed in an appropriate height for ease of observing and operating the monitoring panel.
- The ambient temperature is below 50°C to ensure optimal SUN2000 operation and extend the SUN2000's service life.
- The SUN2000 should be installed in well ventilated environment to ensure good heat dissipation.
- The SUN2000 is not exposed to direct sunlight. Otherwise, the SUN2000 may overheat, resulting in efficiency drop.
- In residential areas, the SUN2000 is not installed on gypsum boards or walls made of similar materials which have a weak sound insulation performance because the noises generated by the SUN2000 disturb residents.
- To ensure good heat dissipation and reserve enough space for installing the SUN2000, the SUN2000 is at least 200 mm, 500 mm, 600 mm, and 1000 mm away from objects on its both sides, top, bottom, and front respectively, as shown in [Figure 4-2](#).

Figure 4-2 Minimum installation clearance



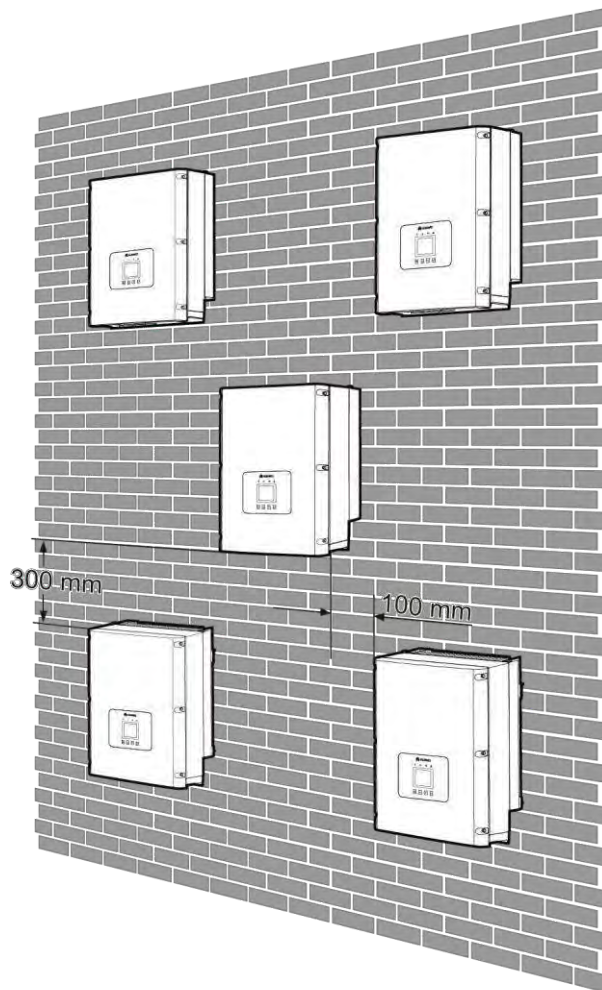
IS01SC0001

- When installing multiple SUN2000s, install them in the same line if sufficient space is available and install them in triangle mode shown in [Figure 4-3](#). If no sufficient space is



available. The stacked installation mode shown in Figure 4-4 is not recommended. The clearance between SUN2000s meets requirements shown in the following figures.

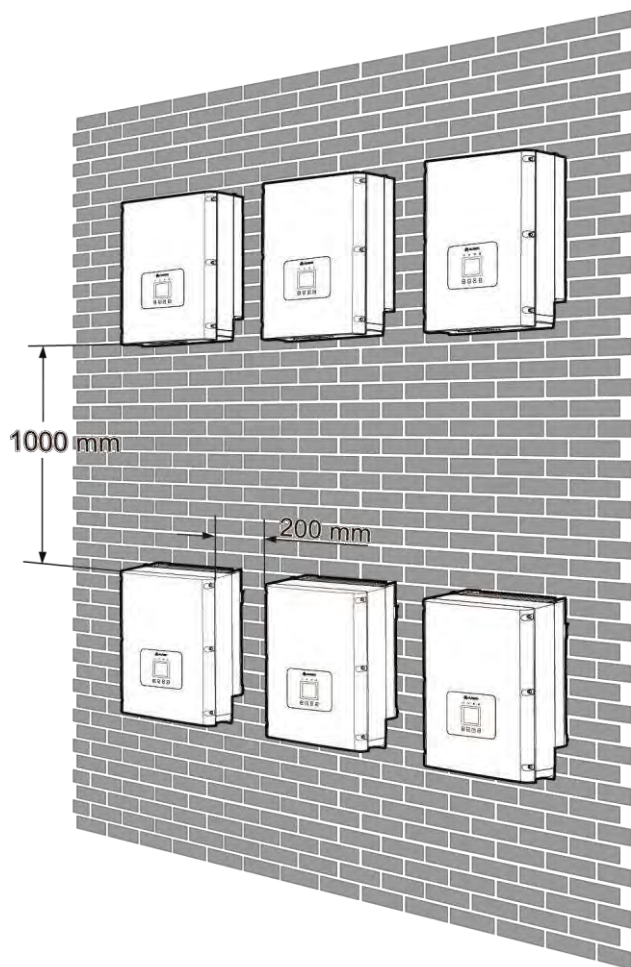
Figure 4-3 Triangle installation mode



IS01SC0002



Figure 4-4 Stacked installation mode



IS01SC0002



NOTICE

If multiple SUN2000s are installed in high temperature areas, enlarge the clearance between SUN2000s to ensure proper heat dissipation.

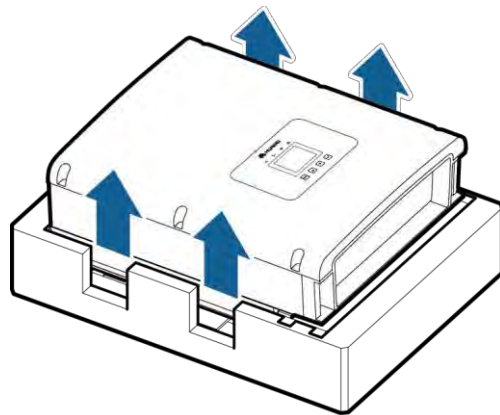
4.4 Moving the SUN2000

This topic describes how to move the SUN2000 to the installation position horizontally.

Procedure

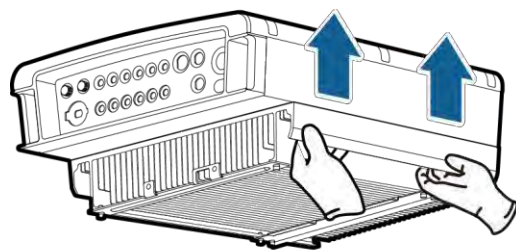
Step 1 Insert hands into the slots on both sides of the SUN2000 and hold the handles, as shown in [Figure 4-5](#) and [Figure 4-6](#). Two persons are required to move the SUN2000.

Figure 4-5 Moving the SUN2000 (1)



IS01HC0001

Figure 4-6 Moving the SUN2000 (2)



IS01HC0002

Step 2 Lift the SUN2000 from the packing case and move it to the installation position.



NOTICE

- To prevent device damage and personal injury, keep balance when moving the SUN2000 because the SUN2000 is heavy.
- Do not put the SUN2000 with its wiring terminals contacting the floor because the power ports and signal ports are not designed to support the weight of the SUN2000. Place the SUN2000 horizontally.
- When placing the SUN2000 on the floor, put foam or paper under the SUN2000 to protect its shell.

----End

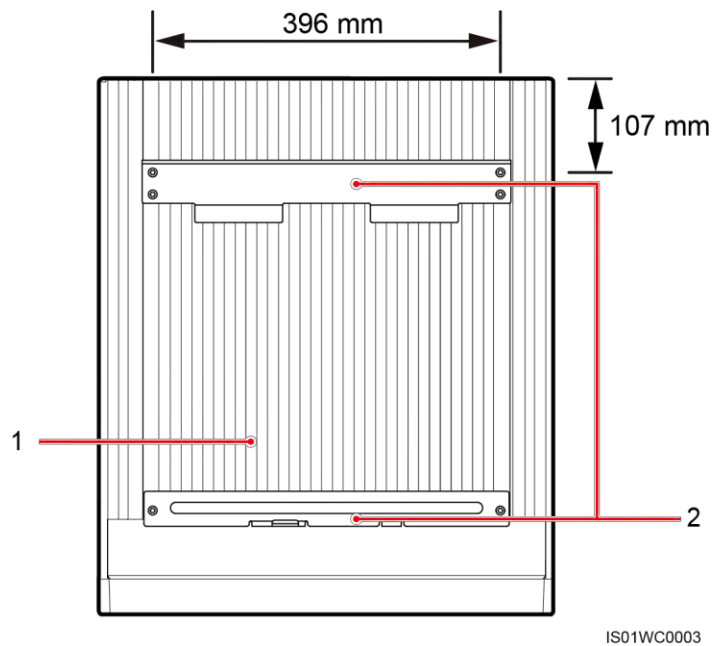
4.5 Support mounting the SUN2000

Before installing the SUN2000, secure the shipped rear panel to the support. Then secure the SUN2000 to the rear panel using hexagon screws.

Cont ext

Figure 4-7 shows the SUN2000 rear view.

Figure 4-7 SUN2000 rear view



1. Heat sink

2. Mounting brackets

NOTE

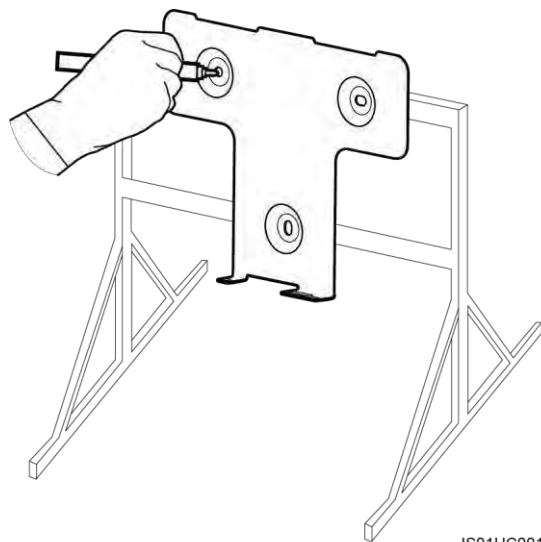
- If the installation location is near the ground, first connect the PGND cable to the ground before installing the SUN2000 on the wall. For details, refer to [5.1 Installing PGND Cables](#).
- You are advised to install the SUN2000 in a position in the same height as your eyes to facilitate operation and maintenance.

Procedure

Step 1 Determine the positions for drilling holes using the rear panel in the packing case, and mark the hole positions using a marker, as shown in [Figure 4-8](#).



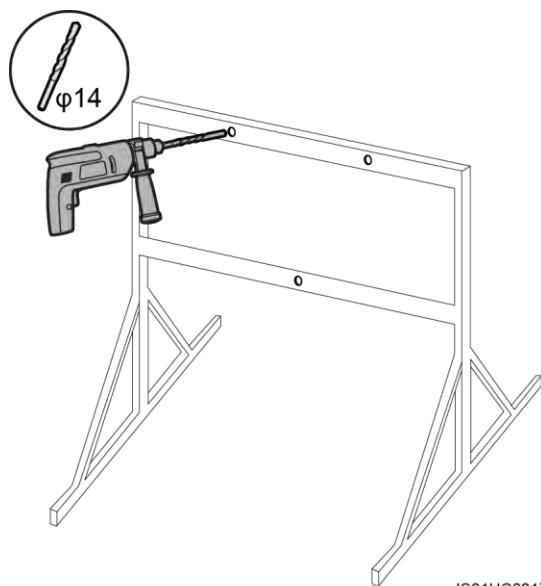
Figure 4-8 Determining hole positions



IS01HC0016

Step 2 Drill holes using a hammer drill, as shown in [Figure 4-9](#).

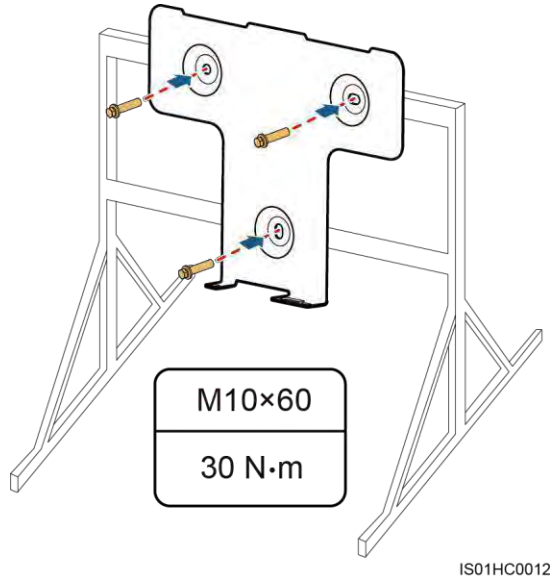
Figure 4-9 Drilling holes



IS01HC0017

Step 3 Align the rear panel with hole positions, insert M10 x 60 bolts into the holes, and tighten the bolts to a torque of 30 N.m using a torque wrench, as shown in [Figure 4-10](#).

Figure 4-10 Securing a rear panel



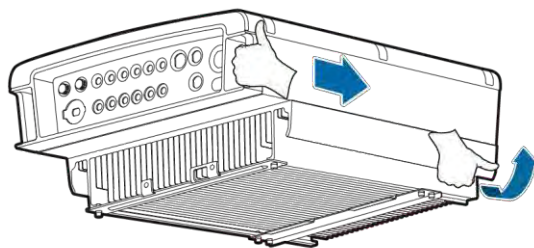
Step 4 Hold the handle at the bottom of the SUN2000 with one hand and hold the end of the other handle near the SUN2000 top with the other end, and then stand the SUN2000, as shown in [Figure 4-11](#). Two persons are required to install the SUN2000.



CAUTION

To prevent personal injury caused by a falling SUN2000, keep balance when lifting the SUN2000 because the SUN2000 has a heavy top.

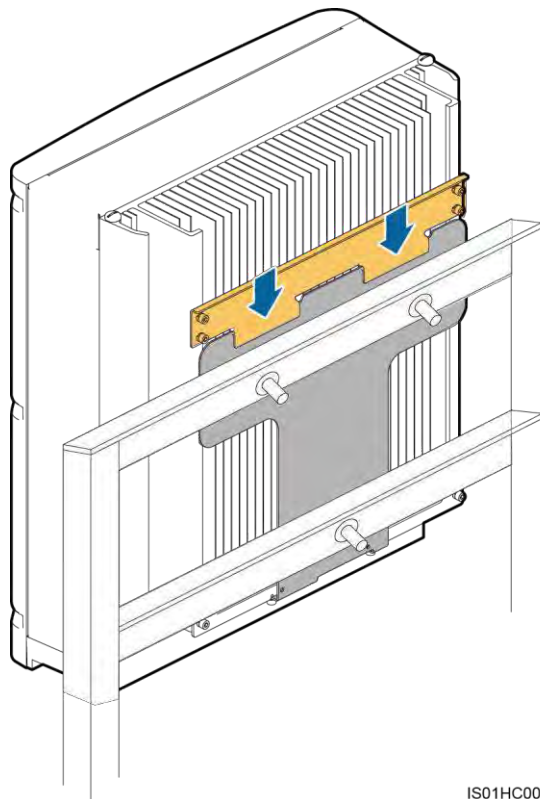
Figure 4-11 Lifting a SUN2000



Step 5 Mount the SUN2000 on the rear panel and keep them aligned with each other, as shown in [Figure 4-12](#).

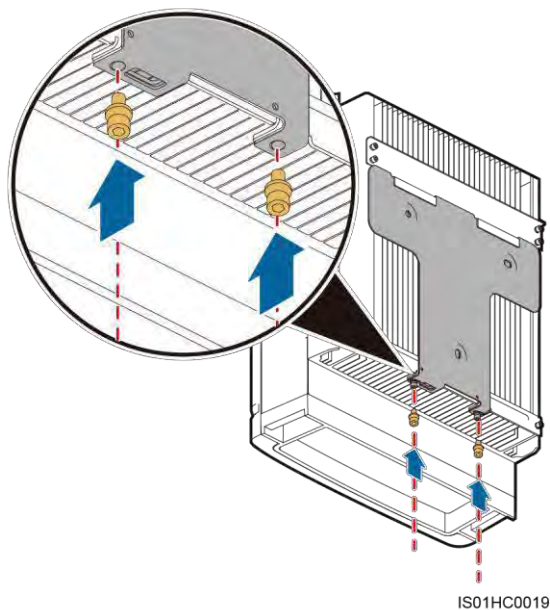


Figure 4-12 Mounting a SUN2000 on a rear panel



Step 6 Tighten the two hexagon screws at the bottom of the SUN2000 to a torque of 5 N.m, as shown in Figure 4-13.

Figure 4-13 Tightening hexagon screws

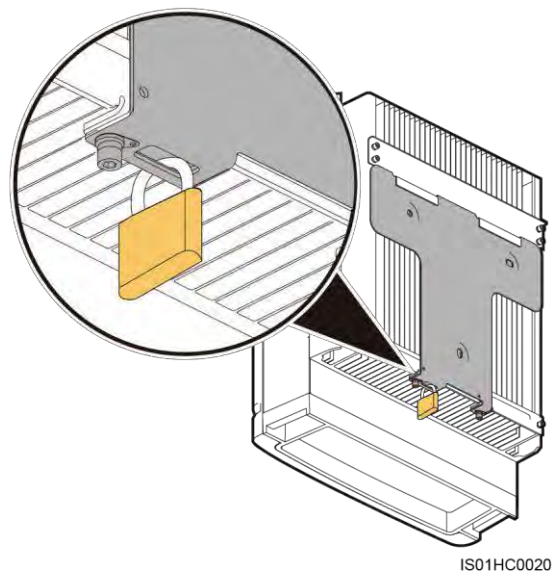




Step 7 (Optional) Install an antitheft lock, as shown in [Figure 4-14](#).

The function of an antitheft lock is to secure the SUN2000 to the rear panel and protect it from stealing.

Figure 4-14 Installing an antitheft lock



----End

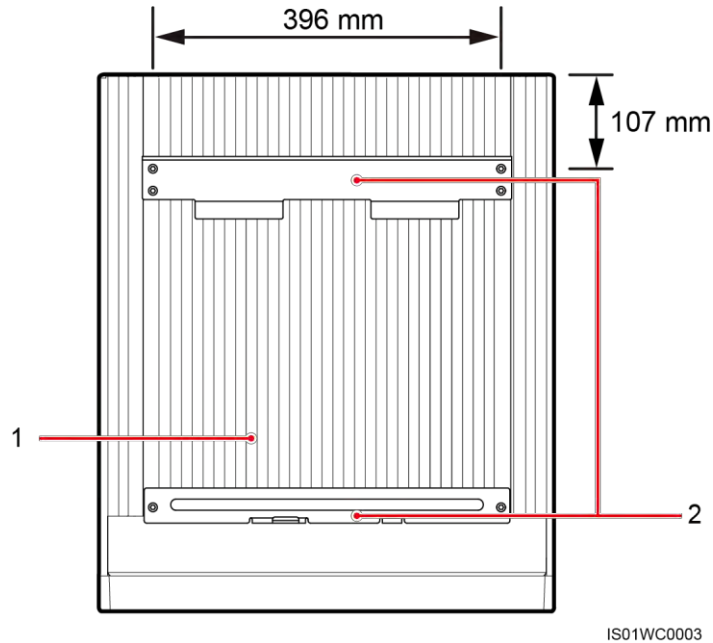
4.6 Wall-mounting the SUN2000

Before installing the SUN2000, secure the shipped rear panel to the wall. Then secure the SUN2000 to the rear panel using hexagon screws.

Context

[Figure 4-15](#) shows the SUN2000 rear view.

Figure 4-15 SUN2000 rear view



NOTE

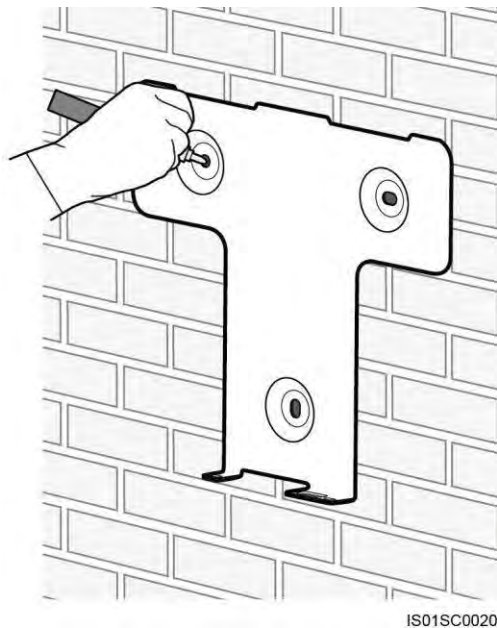
- If the installation location is near the ground, first connect the PGND cable to the ground before installing the SUN2000 on the wall. For details, refer to [5.1 Installing PGND Cables](#).
- You are advised to install the SUN2000 in a position in the same height as your eyes to facilitate operation and maintenance.

Procedure

Step 1 Determine the positions for drilling holes using the rear panel in the packing case, and mark the hole positions using a marker, as shown in [Figure 4-16](#).



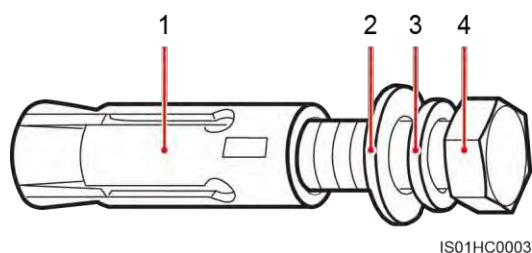
Figure 4-16 Determining hole positions



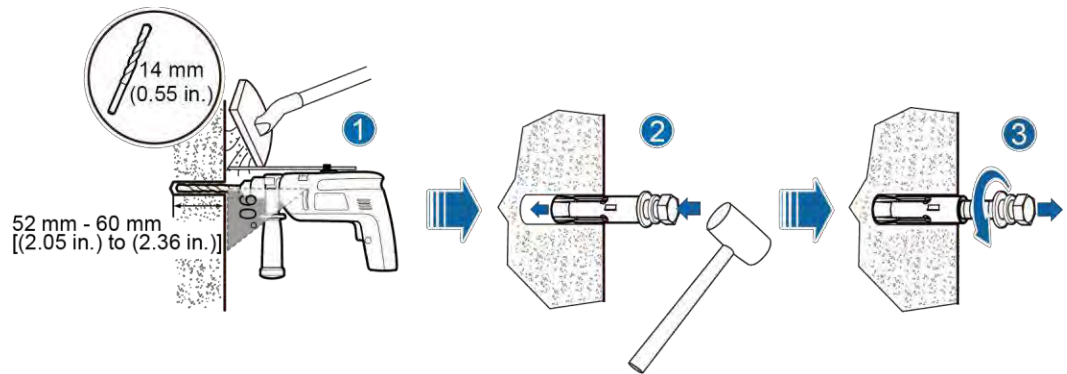
Step 2 Drill holes by using a hammer drill and install expansion bolts, as shown in [Figure 4-18](#).

An expansion bolts contains four parts, as shown in [Figure 4-17](#).

Figure 4-17 Expansion bolt composition



- 1. Expansion sleeve
- 2. Flat washer
- 3. Spring washer
- 4. M10 x 60 bolt

Figure 4-18 Drilling a hole and installing an expansion bolt

IS01HC0004

1. Put a hammer drill with a $\Phi 14$ drill bit on a marked hole position perpendicularly against the wall and drill holes with a depth of 52-60 mm.

**CAUTION**

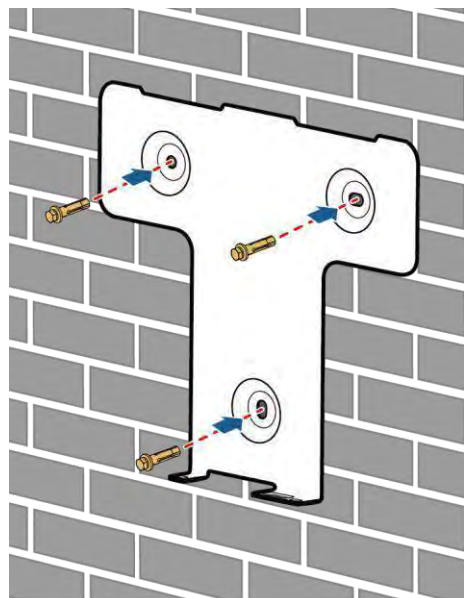
- To prevent dust inhalation or contact with eyes, wear safety goggles and an anti-dust respirator when drilling holes.
 - Vacuum any dust in or around the holes by using a vacuum cleaner and measure the hole distance. If the holes are inaccurately positioned, drill holes again.
2. Vertically insert an expansion bolt into a hole, and knock the expansion bolt completely into the hole by using a rubber mallet.
 3. Remove the M10 x 60 bolt, spring washer, and flat washer by rotating them counterclockwise.

**CAUTION**

Level the front of the expansion sleeve with the concrete wall after removing the bolt, spring washer, and flat washer. Otherwise, the rear panel will not be securely installed on the concrete wall.

- Step 3 Align the rear panel with hole positions, insert expansion bolts into the holes, and tighten the expansion bolts to a torque of 30 N.m using a torque wrench with a 17 mm open end, as shown in [Figure 4-19](#).

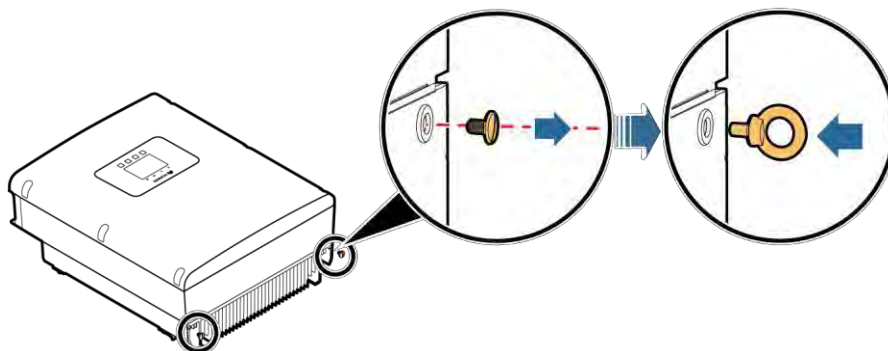
Figure 4-19 Securing a rear panel



IS01HC0005

- Step 4 If the installation position is low and you can mount the SUN2000 on the rear panel, go to [Step 9](#) after performing [Step 7](#).
- Step 5 If the installation position is high and you cannot mount the SUN2000 on the rear panel, perform [Step 6](#) to [Step 10](#).
- Step 6 Remove the two rubber screws from the top of the SUN2000 using a flat-head screwdriver, and install two M10 lifting eyes, as shown in [Figure 4-20](#).

Figure 4-20 Installing lifting eyes



IS01HC0007

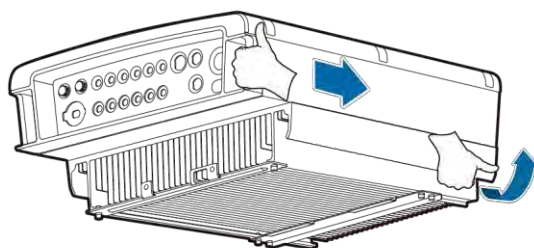
- Step 7 Use one hand to hold the handle at the bottom of the SUN2000 and use the other hand to hold the handle close to the top of the SUN2000 and then stand the SUN2000, as shown in [Figure 4-21](#). Two persons are required to install the SUN2000.



WARNING

To prevent device damage and personal injury, keep balance when lifting the SUN2000 because the SUN2000 has a heavy top.

Figure 4-21 Lifting the SUN2000



IS01HC0006

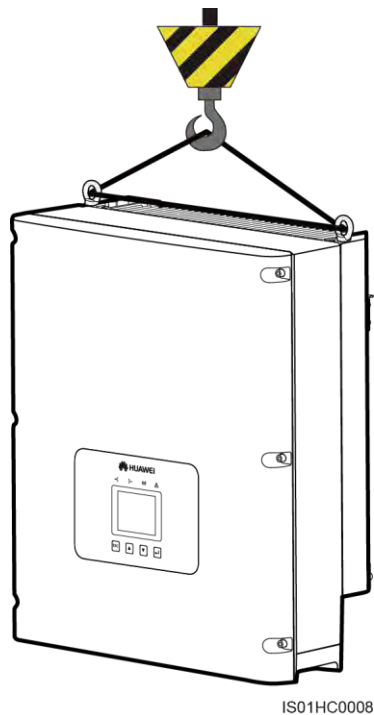
Step 8 Route a rope through the lifting eyes and hoist the SUN2000, as shown in [Figure 4-22](#). The rope must bear the SUN2000 weight.



NOTICE

When hoisting the SUN2000, keep balance to protect the SUN2000 from colliding with the wall or other objects.

Figure 4-22 Hoisting the SUN2000



Step 9 Mount the SUN2000 on the rear panel and keep them aligned with each other, as shown in [Figure 4-23](#) and [Figure 4-24](#).

Figure 4-23 Mounting the SUN2000 on the rear panel (front view)

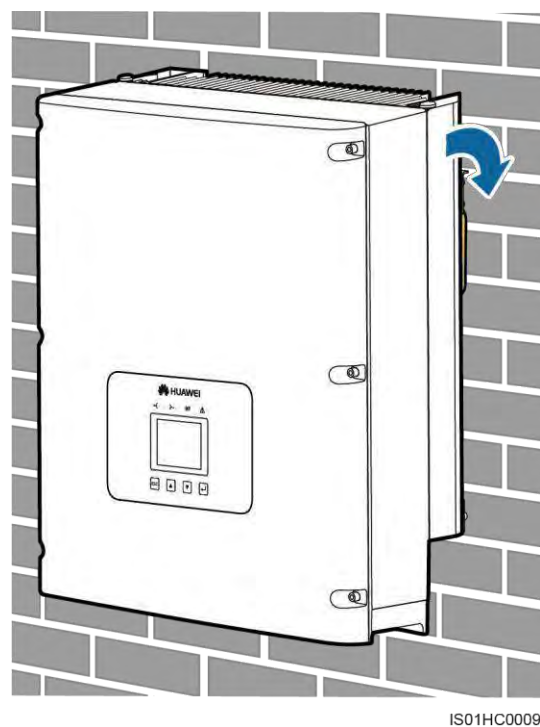
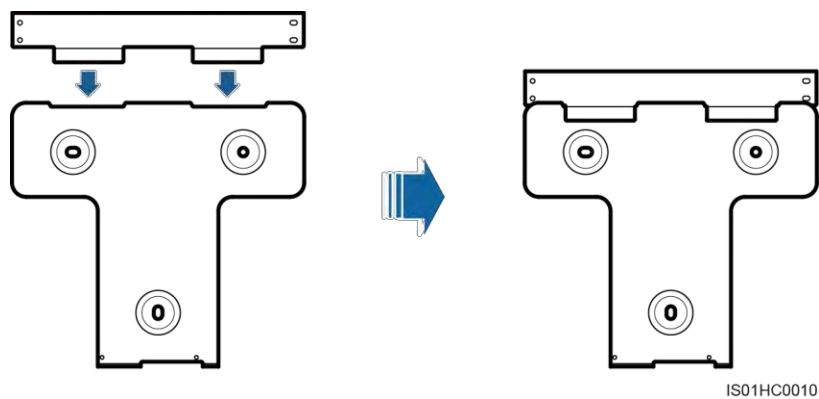


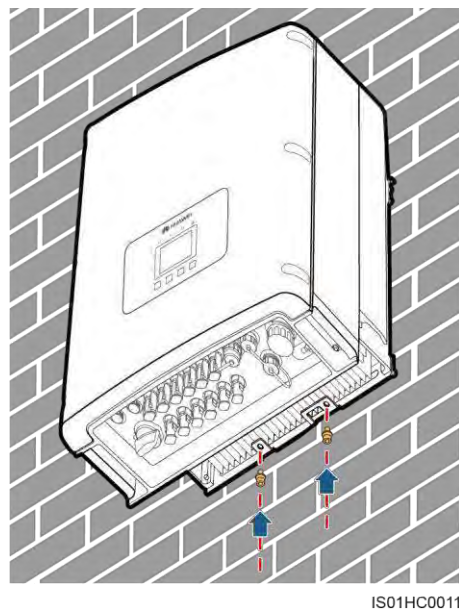


Figure 4-24 Mounting the SUN2000 on the rear panel (rear view)



Step 10 Tighten the two hexagon screws at the bottom of the SUN2000 to a torque of 5 N.m, as shown in [Figure 4-25](#).

Figure 4-25 Tightening hexagon screws

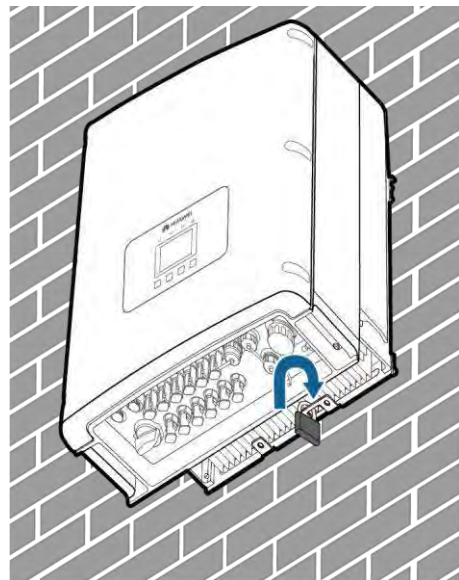


Step 11 (Optional) Install an antitheft lock, as shown in [Figure 4-26](#).

The function of an antitheft lock is to secure the SUN2000 to the rear panel and protect it from stealing.



Figure 4-26 Installing an antitheft lock



IS01HC0029

---End



5 Electrical Connections

This topic describes the SUN2000 electrical connections. Read this part carefully before connecting cables.

Context



DANGER

Before performing electrical connections, ensure that the DC switch is OFF. Otherwise, the high voltage may result in fatal danger.



NOTICE

The cable colors shown in electrical connection schematic drawings are only for reference. Select cables according to local cable specifications (Yellow-green wires are only used for grounding).

5.1 Installing PGND Cables

Connect the SUN2000 to a ground bar over protection ground (PGND) cables for grounding purposes.

Prerequisites

A ground cable has been prepared. JDA recommends an outdoor power cable with a cross-sectional area of 6 mm^2 (10AWG).

Context



NOTE

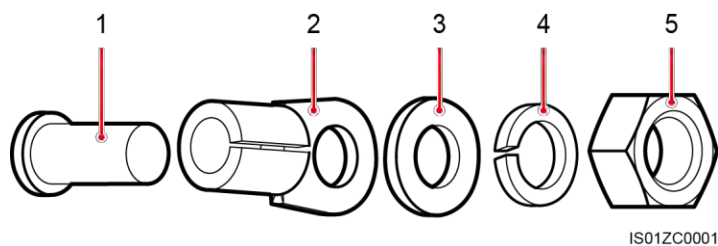
- Good grounding for the SUN2000 can help resist the impact of the surge voltage and improve the EMI performance. First connect the PGND cable before connecting the AC power cable, DC power cable, and communication cable.

For the system with one SUN2000, connect the PGND cable to the ground. For the system with multiple SUN2000s, connect the PGND cables of all SUN2000s to a ground bar in equipotential mode.

- If the installation location is near the ground, first connect the PGND cable to the ground before installing the SUN2000 on the wall.

A ground terminal has five parts, as shown in [Figure 5-1](#).

Figure 5-1 Ground terminal composition

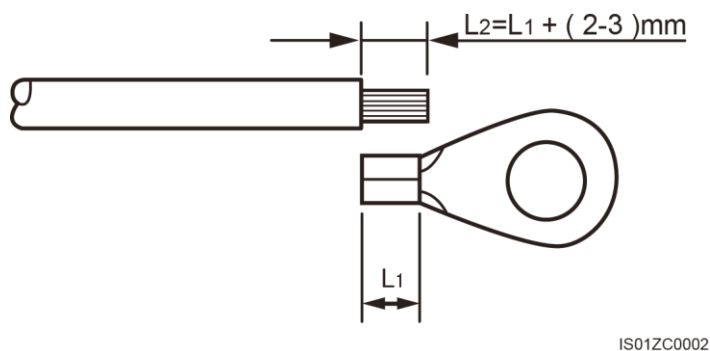


1. M6 welded stud 2. OT terminal 3. Flat washer 4. Spring washer 5. Nut

Procedure

Step 1 Remove the insulation layer with an appropriate length using a wire stripper, as shown in [Figure 5-2](#).

Figure 5-2 Stripped length

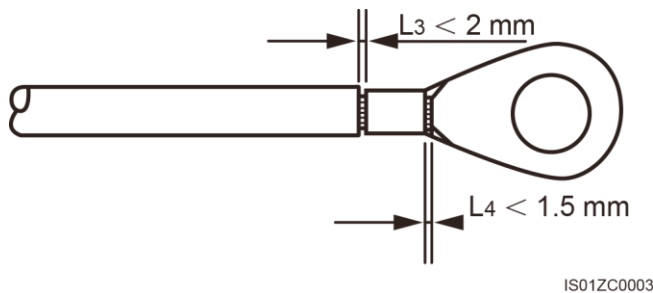


Note: L2 is 2 to 3 mm longer than L1.

Step 2 Insert the exposed core wires into the OT terminal and crimp them by using a crimping tool, as shown in [Figure 5-3](#).

Recommended OT terminals: OT M6.

Figure 5-3 Crimping a cable



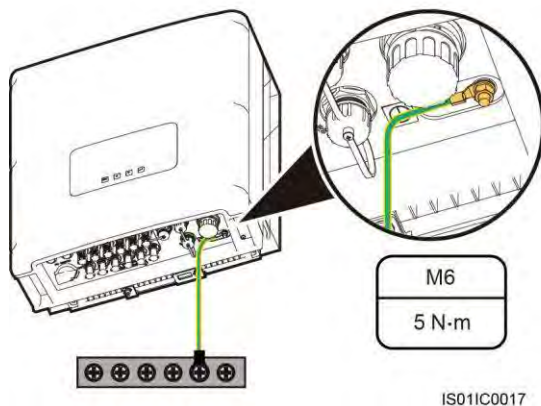
IS012C0003

Note 1: L3 is the length between the insulation layer of the ground cable and the crimped part. L4 is the distance between the crimped part and core wires protruding from the crimped part.

Note 2: The cavity formed after crimping the conductor crimp strip shall wrap the core wires completely. The core wires shall contact the terminal closely.

Step 3 Install the crimped OT terminal, flat washer, and spring washer on the M6 welded stud, and tighten the nut to a torque of 5 N.m using a socket wrench, as shown in [Figure 5-4](#).

Figure 5-4 Installing a ground cable



IS011C0017



NOTE

To enhance the anti-corrosion performance of the ground terminals, apply silica gel on them after connecting the ground cable.

---End

Follow-up Procedure

To disconnect a ground cable, remove the nut from the M6 welded stud using an adjustable wrench, and then remove the spring washer, flat washer, and crimped OT terminal.



5.2 Connecting AC Output Power Cables

Connect the SUN2000 to the AC power distribution frame (PDF) or power grid over AC input power cables.

Prerequisites

An independent three-phase circuit breaker for each inverter must be installed at the output side to ensure that the inverter can be securely disconnected. See [10 Technical Specifications](#) to select the specifications of breaker.



WARNING

- It is not allowed for several inverters to use the same circuit breaker.
- It is not allowed to connect loads between inverter and circuit breaker.

Context

JDA recommends a soft cable for ease of installation. The outer diameter of the conductor should be less than or equal to 4.2 mm. [Table 5-1](#) lists the specifications.

Table 5-1 Recommended AC output power cable specifications

Inverter Model	Cable Type		Cross-sectional Area (mm ²)		External Cable Diameter (mm)	
	Range	Recommended Value	Range	Recommended Value	Range	Recommended Value
SUN2000-8KTL	<ul style="list-style-type: none"> • 4-core outdoor cable (3+N) • 5-core outdoor cable (3+N+PE) 	4-core outdoor cable (3+N)	4-10 (12AWG-8AWG)	4 (12AWG)	NOTE <ul style="list-style-type: none"> • When the outer cable diameter ranges from 11 mm to 13 mm, add cable clamps. • When the outer cable diameter ranges from 16 mm to 20 mm, strip a seal ring from the cable sealing cover interior. • When the outer diameter of an armored cable exceeds 20 mm, strip the jacket and armored layer and take waterproof and 	15
SUN2000-10KTL						
SUN2000-12KTL						
SUN2000-15KTL			6-10 (10AWG-8AWG)	6 (10AWG)		
SUN2000-17KTL						
SUN2000-20KTL						
SUN2000-23KTL						
SUN2000-24.5KTL	<ul style="list-style-type: none"> • 3-core outdoor 	3-core outdoor cable				

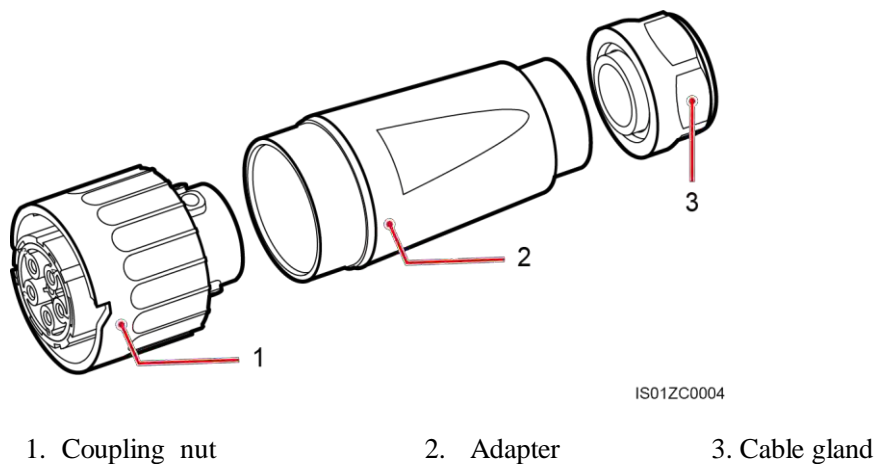
Inverter Model	Cable Type		Cross-sectional Area (mm ²)		External Cable Diameter(mm)	
	Range	Recommended Value	Range	Recommended Value	Range	Recommended Value
SUN2000-28KTL	cable • 4-core outdoor cable (3+PE)				ultraviolet-proof measures on the cable.	

 **NOTICE**

- If the ground cable has been installed according to [5.1 Installing PGND Cables](#), you do not have to connect the PE wire of the AC output power cable.
- If a cable with a cross-sectional area of 4 mm² to 10 mm² is used, crimp a tubular cord end terminal at the cable end before installing the cable.

An AC output connector has three parts: coupling nut, adapter, and cable gland, as shown in [Figure 5-5](#).

Figure 5-5 AC output connector



Procedure

- Step 1 Remove the cable gland and the adapter from the AC output connector.
- Step 2 Remove the insulation layer of the AC output cable of an appropriate length using a wire stripper.

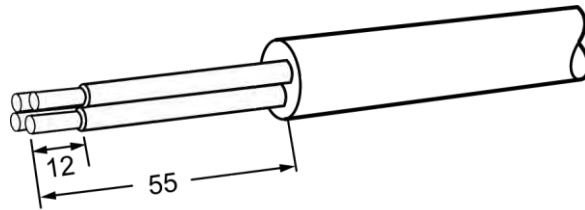


NOTICE

The three-phase AC input power cables, neutral cable, and PGND cable must be properly connected. (No neutral cable connections are involved for the SUN2000-28KTL.)

1. Strip the outer jacket of AC output cable by 55 mm.
2. Strip the insulation layer of each core wires by 12 mm.

Figure 5-6 Stripped length (unit: mm)



IS01ZC0005



NOTE

The preceding figure shows only how to strip cables for the SUN2000-8KTL to SUN2000-23KTL. For the SUN2000-28KTL, align the neutral cable with the protective jacket and cut off the neutral cable.



CAUTION

When cutting off the cable, take protective measures to prevent the cable from splashing and hurting people.

Step 3 Insert AC output cable (L1, L2, L3 and N) into the cable gland and the adapter, as shown in [Figure 5-7](#) and [Figure 5-8](#).



NOTE

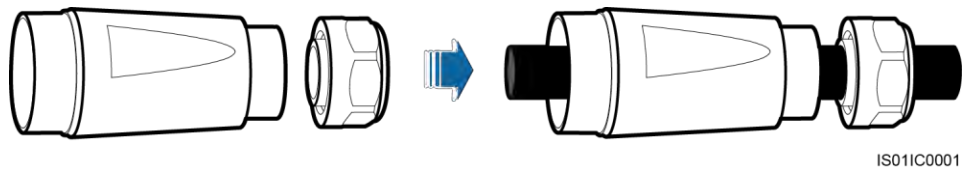
When the outer diameter of the cable is greater than 16 mm, remove a seal ring from the cable gland before inserting the power cable into the cable gland and the adapter.

Figure 5-7 Stripping a seal ring



IS01ZC0006

Figure 5-8 Installing a cable sealing cover and socket

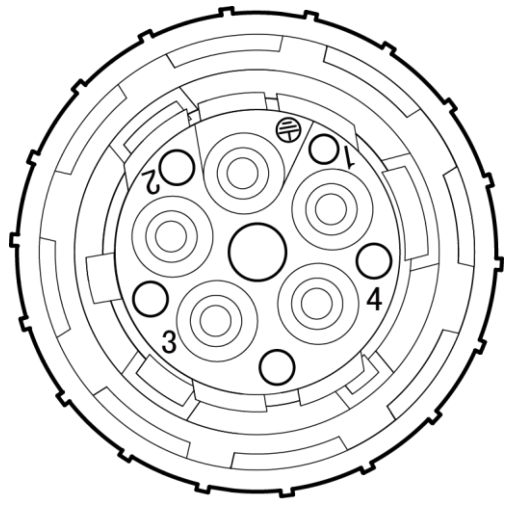


IS011C0001

Step 4 Loosen the screws inside the coupling nut holes using a flat-head screwdriver, insert the core wires into corresponding holes, and tighten the screws, as shown in [Figure 5-9](#) and [Figure 5-10](#).

Tighten the screws to a torque of 0.7 N.m.

Figure 5-9 Auxiliary connector



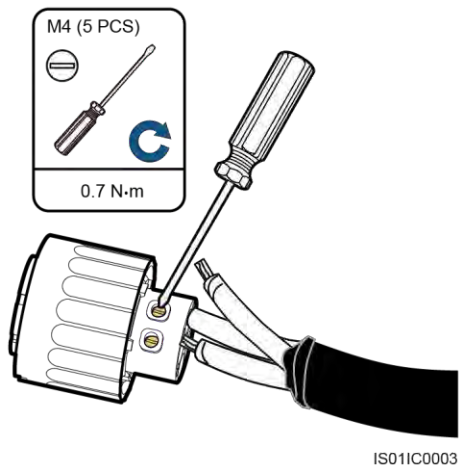
IS011C0002

- Connect L1 to the hole numbered 1.
- Connect L2 to the hole numbered 2.
- Connect L3 to the hole numbered 3.
- Connect N to the hole numbered 4.

For the SUN2000-28KTL, do not connect the neutral cable to the hole numbered 4.

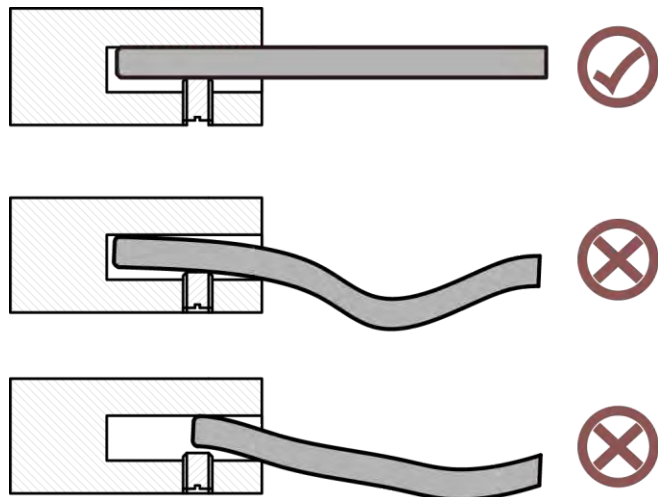


Figure 5-10 Connecting cables to an auxiliary connector



Step 5 Check that all core wires are properly connected, as shown in [Figure 5-11](#).

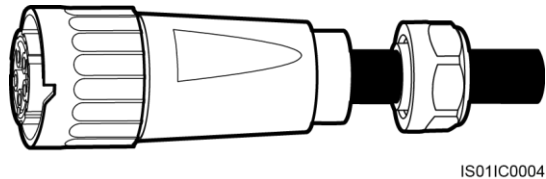
Figure 5-11 Checking the cable connection



Step 6 Secure the adapter to the coupling nut, as shown in [Figure 5-12](#).

Tighten the adapter to a torque of 1-2 N.m.

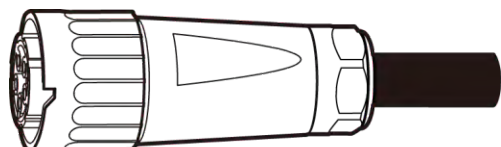
Figure 5-12 Installing a socket



Step 7 Secure the cable gland to the adapter, as shown in [Figure 5-13](#).

Tighten the cable gland to a torque of 5 N.m (You need to use some tool to achieve this torque).

Figure 5-13 Installing a cable sealing cover

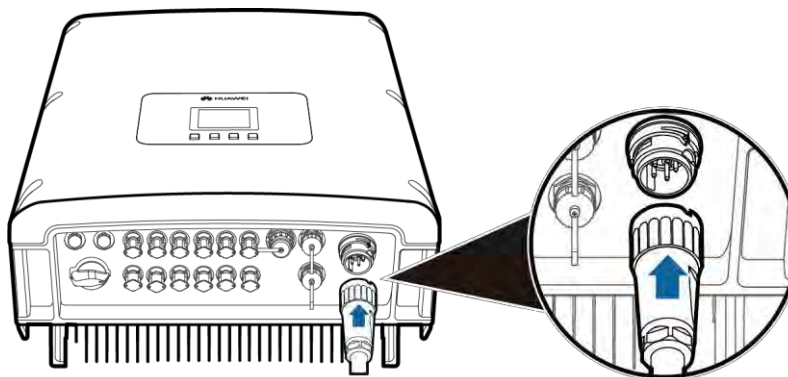


IS011C0005

Step 8 Connect the AC output connector to the bayonet coupling of the AC output wiring terminal on the SUN2000 and rotate it clockwise until you hear a "click" sound, as shown in [Figure 5-14](#).

Because no sufficient space is available on the right of the AC terminal, tighten the terminal using the left hand.

Figure 5-14 Connecting an AC output connector



IS011C0006



NOTICE

The AC output connector securely connects to the AC output wiring terminal after the bayonet coupling snaps into place.

----End

Follow-up Procedure

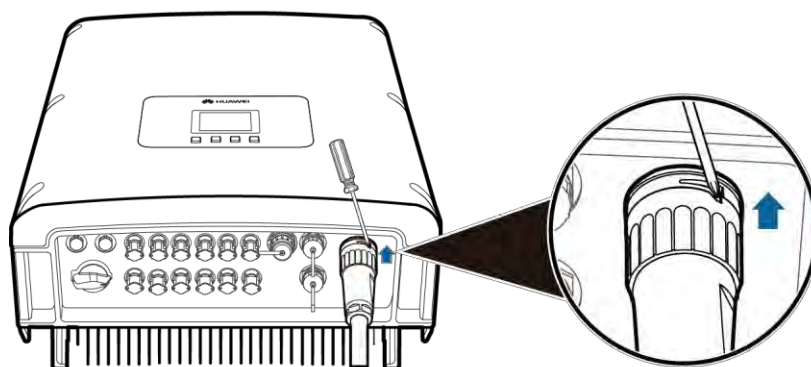
To remove an AC output connector from the SUN2000, press the locking plate on the coupling nut using a flat-head screwdriver and rotate the AC output connector counterclockwise, as shown in [Figure 5-15](#).



CAUTION

Before removing the AC output connector, disconnect the circuit breaker between the SUN2000 and the power grid.

Figure 5-15 Removing an AC output connector



IS01IC0007

5.3 Installing DC Input PowerCables

Connect the SUN2000 to PV arrays over DC input power cables

Prerequisites

- PV modules generate electric energy when exposed to sunlight and can create an electrical shock hazard. Therefore, when connecting DC input power cables, cover PV modules by using opaque cloth.
- Before performing electrical connections, ensure that voltages of the DC cables should be within the safe voltage range, that is, lower than 60 V DC, and the DC SWITCH is OFF. Otherwise, the high voltage may result in fatal danger.



WARNING

Ensure that the following conditions are met. Otherwise, fire accident may occur.

- PV modules connected in series in each PV array are of the same specifications.
- The open-circuit voltage of each PV array is always lower than or equal to 1000 V DC.
- The open-circuit voltage of each PV array is always lower than or equal to 23 A DC.
- The positive and negative terminals of PV arrays connect to the positive and negative DC input terminals respectively.



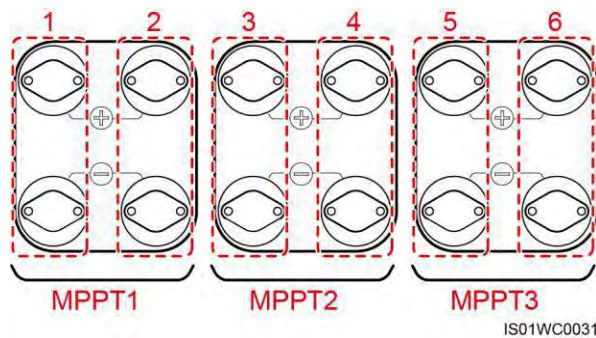
CAUTION

- If the SUN2000 connects to the power grid directly, ensure that the PV arrays are not grounded.
- If the DC voltage is a non-zero value between the positive terminal of PV arrays and the ground, the PV arrays are subject to insulation faults. Rectify the fault before connecting cables.
- During PV array and SUN2000 installation, the positive or negative terminals of PV arrays may be grounded if power cables are not properly installed or routed. In this case, an AC or DC short circuit may occur and damage the SUN2000.
- If the PV arrays need to be grounded, install a three-phase four-wire isolation transformer on the output side and set the parameter of **Isolation** to **Input Grounded, With TF** by referring to [7.2.11 Setting Isolation Parameters](#). If no isolation transformer is connected, the SUN2000 will not operate properly.

Context

Figure 5-16 shows the MPPT distribution of the SUN2000.

Figure 5-16 MPPT distribution



- The SUN2000-8KTL to SUN2000-12KTL provide two MPPT routes to track the maximum power point for PV strings. Therefore, two to four DC inputs should be evenly distributed on two terminal groups.
- The SUN2000-15KTL to SUN2000-28KTL provide three MPPT routes to track the maximum power point for PV strings. Therefore, two to six DC inputs should be evenly distributed on three terminal groups.

DC input cables with the specifications specified in [Table 5-2](#) are recommended.



Table 5-2 Recommended DC input cable specifications

Cable Type	Cross-Sectional Area(mm ²)		External Cable Diameter (mm)
	Range	Recommended Value	
Common PV cables in the industry	4-6	4	4.5-7.8



NOTICE

Cables with high rigidity, such as armored cables, are not recommended, because poor contact may be caused by the bending of the cables.

DC input connectors are classified into positive and negative connectors, as shown in [Figure 5-17](#) and [Figure 5-18](#).

Figure 5-17 Positive connector composition

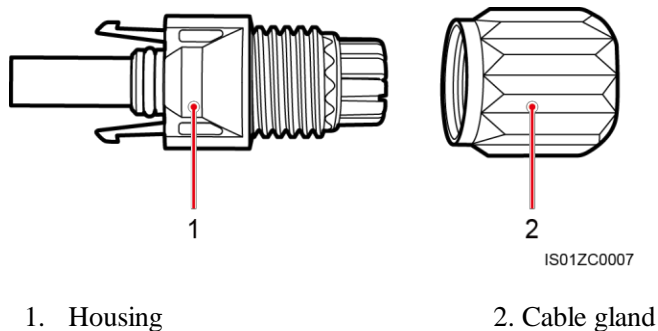
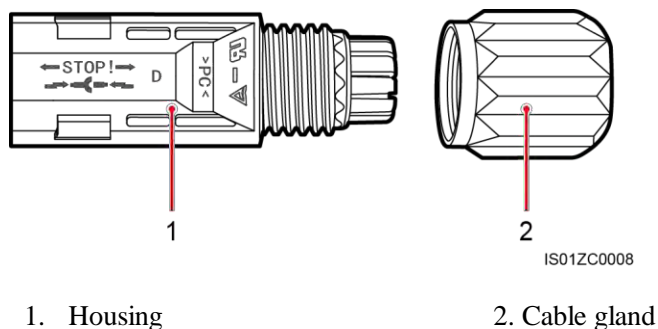


Figure 5-18 Negative connector composition



 **NOTICE**

Positive and negative metal terminals are packed with positive and negative connectors respectively. Separate the positive from negative metal terminals after unpacking the SUN2000 to avoid confusing the polarities.

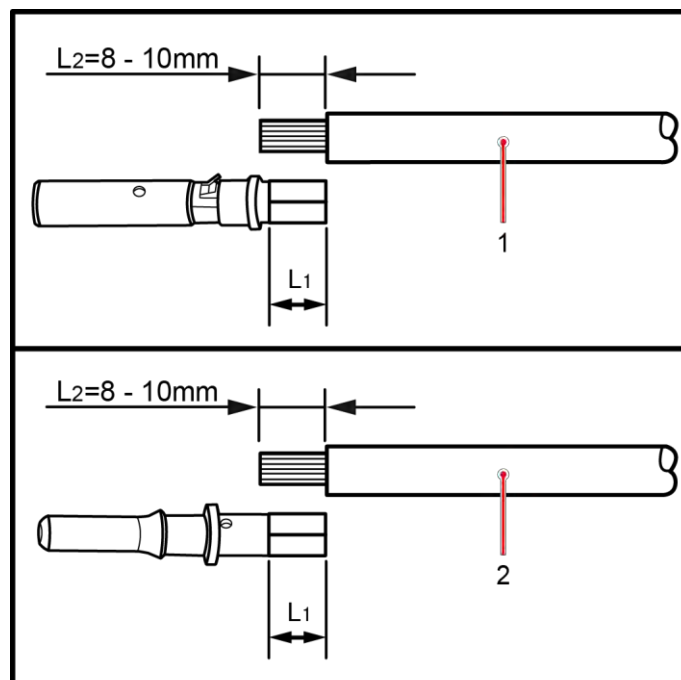
Procedure

- Step 1 Remove cable glands from the positive and negative connectors.
 - Step 2 Remove the insulation layer with an appropriate length from the positive and negative power cables by using a wire stripper as show in [Figure 5-19](#).
- PV power cables with a cross-sectional area of 4 mm² are recommended.

 **NOTICE**

Cables with high rigidity, such as armored cables, are not recommended, because poor contact may be caused by the bending of the cables.

Figure 5-19 Connecting DC input power cables (1)



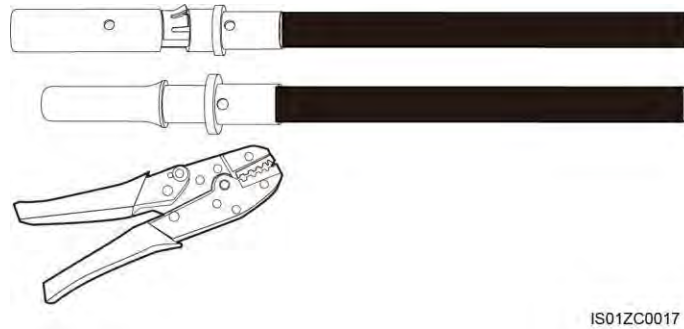
IS01ZC0009

1. Positive power cable

2. Negative power cable

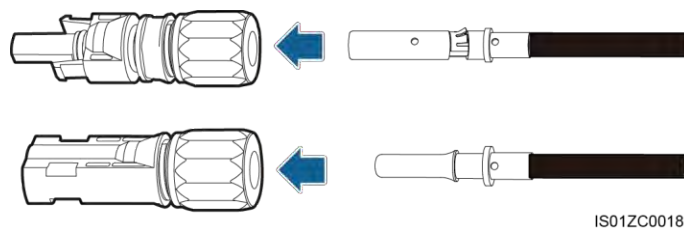
Step 3 Insert the stripped positive and negative power cables into the positive and negative metal terminals respectively and crimp them using a crimping tool. Ensure that the cables are crimped until they cannot be pulled out by force less than 400 N, as shown in [Figure 5-20](#).

Figure 5-20 Crimping a metal terminal



Step 4 Insert crimped positive and negative power cables into corresponding insulation covers until they snap into place, as shown in [Figure 5-21](#).

Figure 5-21 Engaging metal terminals



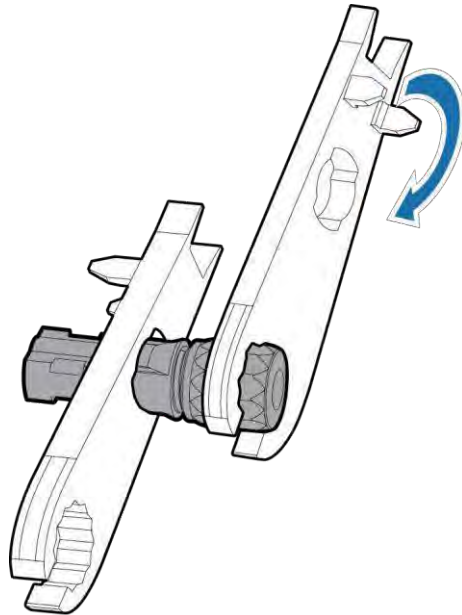
NOTICE

Insert the crimped positive and negative power cables into the corresponding insulation covers. Check that the cables are in position by slightly pulling them back.

Step 5 Reinstall cable glands on positive and negative connectors and rotate them against the insulation covers.

It is recommended that you secure the nut by using removal wrenches, as shown in [Figure 5-22](#).

Figure 5-22 Locking a nut

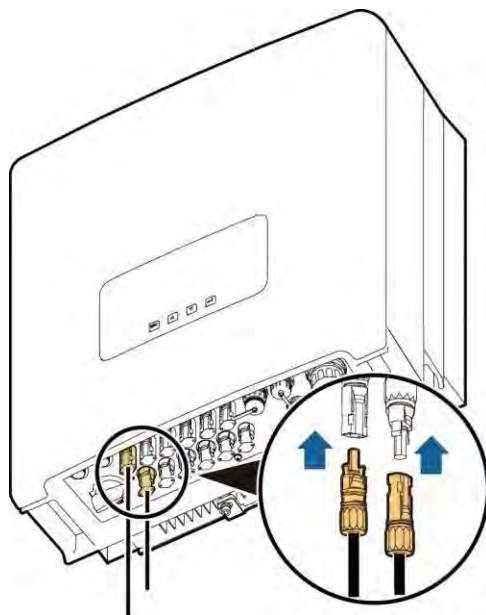


IS011C0016

Step 6 Take off the blue dustproof plugs from the bottom of the DC input connectors.

Step 7 Insert the positive and negative connectors into corresponding DC input terminals of the SUN2000 until you hear a "click" sound, as shown in [Figure 5-23](#).

Figure 5-23 Positive and negative connectors



IS011C0028



NOTICE

After the positive and negative connectors are in position, the clearance between the DC terminals and connectors should be less than or equal to 0.8 mm.

----End

Follow-up Procedure

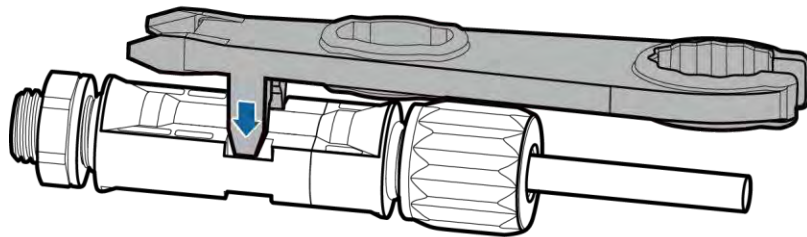
To remove the positive and negative connectors from the SUN2000, insert a removal wrench into the bayonet and press the wrench with an appropriate strength, as shown in [Figure 5-24](#).



WARNING

Before removing the positive and negative connectors, ensure that the DC SWITCH is OFF.

Figure 5-24 Removing a DC input connector



IS011C0010

5.4 Connecting Communications Cables

This topic describes the functions of USB and RS485 ports and the method of connecting RS485 communications cables.

5.4.1 Communications Port Description

This topic describes the functions of the USB and RS485 ports.

Overview

The SUN2000 has three communications ports: USB port, RS485 IN port, and RS485 OUT port. They are on the left, upper right, and lower right respectively. For details, see (4), (5), and (6) in [Appearance](#).

USB Port

The SUN2000 communicates with the USB flash drive over a USB port to implement functions of firmware upgrade, configuration loading, data downloading, and configuration downloading.

RS485 Port

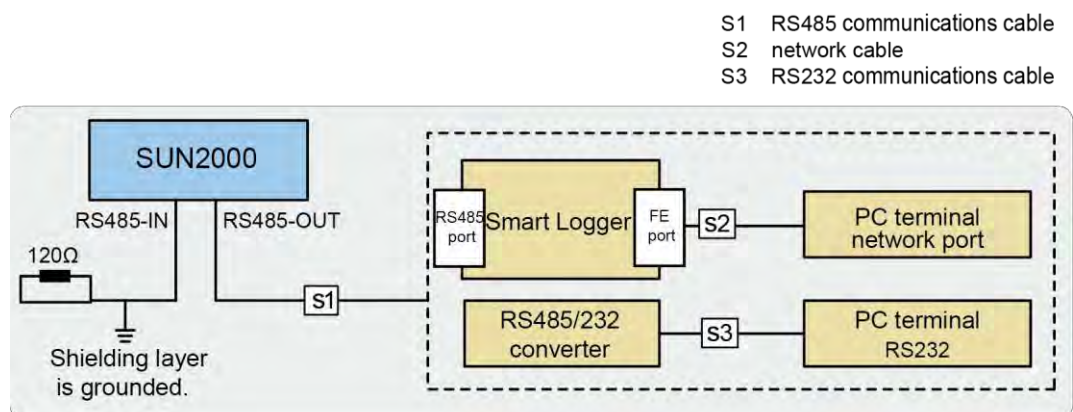
The SUN2000 communicates with the RS485 port to send the data of energy yield, alarm information, and running status to the PC terminal of the element management system (EMS) monitoring software (such as the NetEco) and the local data collector (such as the Smart Logger).

The SUN2000 communicates with the RS485 port by using the following methods:

- If only one SUN2000 is used, use a communication cable with waterproof RJ45 connectors, and choose either of the two RS485 ports and cover the unused port by using a waterproof cover.
 Set **Match Resistance** of the inverter to **Connect** in **Comm. Param.** (For details about this, see [7.2.8 Setting Communications Parameters](#)), and the single point of the shielded layer of the communication cable must be grounded.
- If multiple SUN2000s are used, connect all SUN2000s in daisy chain mode over the RS485 communication cable.
 Set **Match Resistance** of every inverter at the end of the daisy chain to **Connect** in **Comm. Param.** (For details about this, see [7.2.8 Setting Communications Parameters](#)), and the single point of the shielded layer of the communication cable must be grounded.
- Connect the SUN2000 to the PC terminal over an RS485/RS232 converter to implement communication.
- Connect the SUN2000 to the Smart Logger to perform data collection and monitoring, or connect to the PC terminal over the Smart Logger to implement communication.

[Figure 5-25](#) shows how one SUN2000 connects to the Smart Logger and the PC terminal.
[Figure 5-26](#) shows how multiple SUN2000s connect to the Smart Logger and the PC terminal.

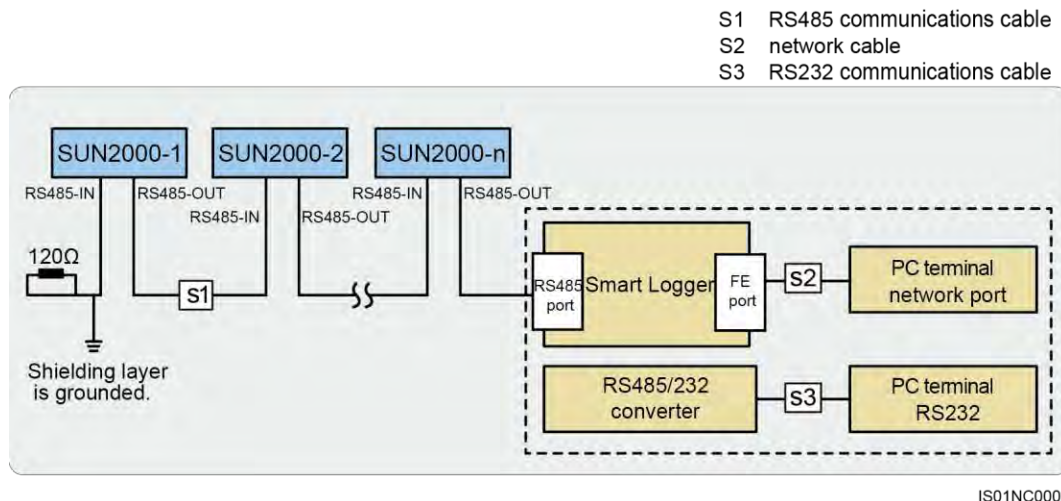
Figure 5-25 RS485 communication mode (1)



IS01NC0001



Figure 5-26 RS485 communication mode (2)



NOTE

- The length of the communication cable should be less than 1000 m.
- If multiple SUN2000s are connected to the monitoring device over an RS485/RS232 converter, a maximum of six SUN2000s can be connected in a daisy chain.
- If multiple SUN2000s are connected to a Smart Logger, a maximum of 60 SUN2000s can be connected in three daisy chains (a maximum of 20 SUN2000s is supported in one daisy chain).

5.4. Connecting RS485 Communications Cables

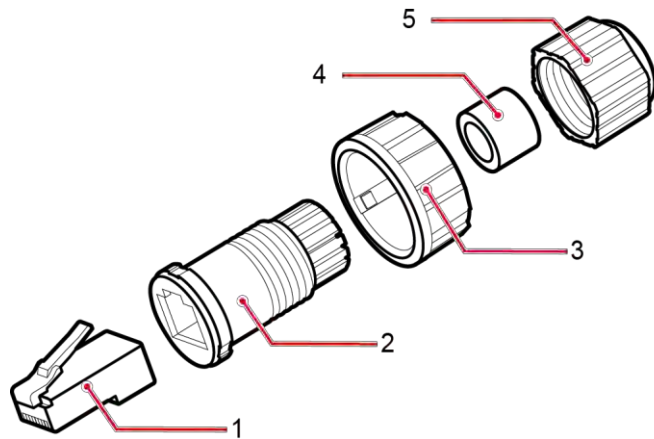
Connect the SUN2000 to communications equipment (such as the data collector and PC terminal) over RS485 communications cables.

Context

You are recommended to use 24 AWG outdoor shielded network cables with the internal resistance less than or equal to 1.5 ohms/10 m and external diameter of 4.5 mm to 7.5 mm as RS485 communications cables.

A waterproof RJ45 connector has five parts: plug, housing, screw nut, seals, and sealingnut. See [Figure 5-27](#).

Figure 5-27 Waterproof RJ45 connector composition



IS01ZC0010

- | | | |
|----------|----------------|--------------|
| 1. Plug | 2. Housing | 3. Screw nut |
| 4. Seals | 5. Sealing nut | |



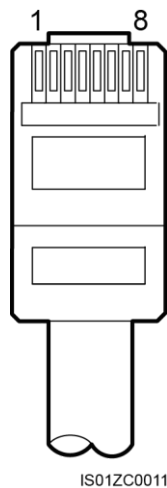
NOTICE

When routing communications cables, ensure that communications cables are separated from power cables and away from interference sources to prevent communication interruptions.

Procedure

- Step 1 Remove the insulation layer of an appropriate length from the shielded network cable using a wire stripper.
- Step 2 Insert the shielded network cable into the sealing nut, seals, screw nut, and housing.
- Step 3 Connect the stripped network cable to corresponding pins on the plug, as shown in [Figure 5-28](#).

Figure 5-28 Connecting a communications cable (1)



IS012C0011

Figure 5-28 shows the side without a clip.

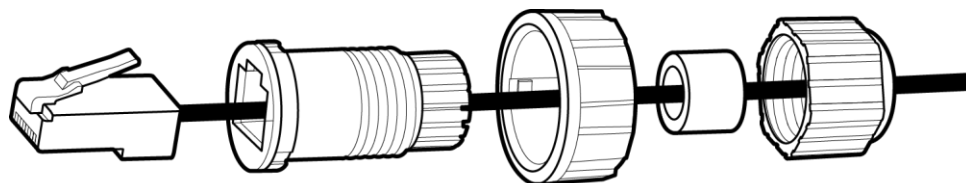
Table 5-3 lists the cable colors and functions.

Table 5-3 Cable colors and functions

No.	Color	Function
1	White and orange	RS485A, RS485 differential signal +
2	Orange	RS485B, RS485 differential signal -
3	White and green	PGND
4	Blue	RS485A, RS485 differential signal +
5	White and blue	RS485B, RS485 differential signal -
6	Green	PGND
7	White and brown	PGND
8	Brown	PGND



Figure 5-29 Connecting a communications cable (2)

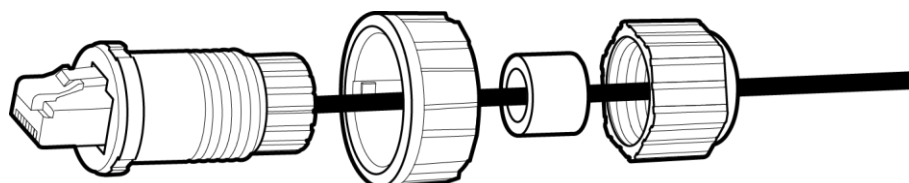


IS011C0011

Step 4 Crystal plug with RJ11 crimping tool.

Step 5 Secure the housing to the plug, as shown in [Figure 5-30](#).

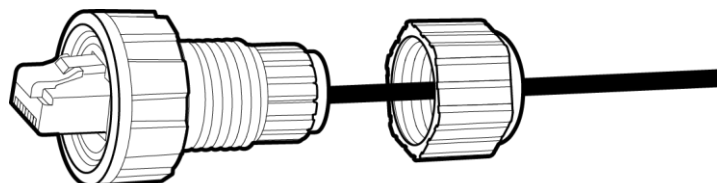
Figure 5-30 Connecting a communications cable (3)



IS011C0012

Step 6 Insert the seals into and secure the screw nut to the housing, as shown in [Figure 5-31](#).

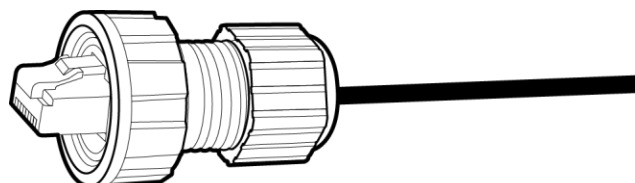
Figure 5-31 Connecting a communications cable (4)



IS011C0013

Step 7 Secure the sealing nut to the housing, as shown in [Figure 5-32](#).

Figure 5-32 Connecting a communications cable (5)



IS011C0014

Step 8 Insert the plug into the RS485 port on the SUN2000, and tighten the screw nut.

----End



Follow-up Procedure

To remove an RJ45 connector from the SUN2000, remove the screw nut, press the clip on the RJ45 connector, and then pull out the shielded RJ45 connector.



6 System Operation

6.1 Checking Before Power -On

To ensure the normal SUN2000 operating, check the SUN2000 before powering it on.

Before powering on the SUN2000, check that:

1. The SUN2000 is installed correctly and securely.
2. The ground cable is securely connected.
3. All AC output power cables are properly connected.
4. All DC input power cables are properly connected.
5. Unused DC input terminals are sealed.
6. Idle USB and RS485 ports are blocked with waterproof plugs.

6.2 Powering on the SUN2000

This topic describes how to power on the SUN2000 after electrical connection is complete.

Procedure

- Step 1 Switch on the AC circuit breaker between the SUN2000 and the power grid.



NOTICE

If you perform [Step 2](#) before [Step 1](#), the SUN2000 generates an abnormal shutdown alarm. You can start the SUN2000 only after faults are automatically rectified. The default alarm clearance time is 5 minutes. You can modify the time over the EMS software of the PC terminal.



NOTE

The monitoring panel can be activated only after power is supplied to the DC or AC side.

- Step 2 Ensure that the **DC SWITCH** at the bottom of the SUN2000 is **ON**.



Step 3(Optional) Measure the temperatures at the joints between the DC terminals and the connectors by using a point thermometer.

---End

6.3 Setting Initialization Parameters

When starting the SUN2000 for the first time, set initialization parameters on the monitoring panel. The initialization parameters include the system language, system time, and power grid standard code.

Context

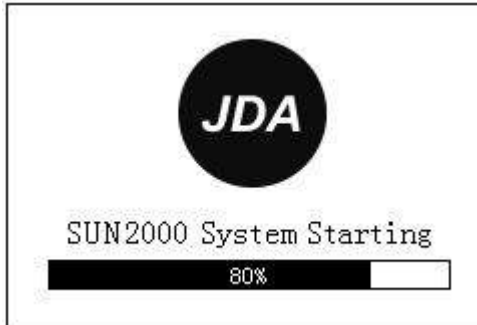



NOTE











If the SUN2000 is started for the first time, set the initialization parameters by referring to this section. If the SUN2000 is not started for the first time, it will enter the startup detection page.

Procedure

- The following table describes the process for setting initialization parameters. The parameter values in the figures are for reference only.

LCD	Operation Procedure
	<p>1. After startup, the SUN2000 enters the initialization page. The default system language is English.</p>
	<p>2. Press Enter to enter the Wizard page. To return to the default page, press ESC. To reset initialization parameters in the future, choose Settings > Wizard as Advanced User.</p>



LCD	Operation Procedure
<pre>Initialization->Wizard Language English 中文 Deutsch Italiano Français Polski</pre>	<p>3. After selecting a display language, click .</p> <p>The pages will be displayed in the selected language.</p>
<pre>Initialization->Wizard Date&Time Date:2013-06-17 Time:09:42:17</pre>	<p>4. After setting the correct date and time, click .</p> <ul style="list-style-type: none"> To select the parameter, click . To set the parameter value, set  or . The date is displayed in the format of YYYY-MM-DD. The time is displayed in the format of hh-mm-ss. in which hh, mm, and ss stand for hour, minute, and second respectively.
<pre>Initialization->Wizard Grid Code VDE-AR-N4105 CGC/GF004:2011 VDE-0126-1-1-FR-A VDE-0126-1-1-FR-B VDE-0126-1-1-FR-C VDE-0126-1-1-BU</pre>	<p>5. After setting the power grid standard code, click .</p> <p>To select a power grid standard code, click  or .</p> <p>NOTE</p> <ul style="list-style-type: none"> When the illumination is weak, the grid code cannot be successfully set. Wait until the illumination becomes sufficient, log in to the system as Advanced User, and choose Settings > Init Wizard to set the grid code. The SUN2000-28KTL applies only to the medium-voltage grid-feeding scenarios. The power grid standard codes supported are the China medium-voltage grid standard code, Germany medium-voltage grid standard code, and user-defined medium-voltage grid standard code.
<pre>Initialization->Wizard Finished Language:English Time:2012-01-01 00:38:06 Grid Code:VDE-AR-N4105 :Confirm</pre>	<p>6. On the Finished page, click .</p>



NOTICE

For multiple SUN2000s networked, after the initialization parameters are set, you need to set the address and baud rate for each SUN2000 by following the rules below:

- Addresses for all SUN2000s in the same daisy chain should be different from each other. Addresses of all devices in the daisy chain should be in the scope of the SmartLogger address and different from each other, if communication with the SmartLogger is required.
- Baud rates of all SUN2000s in the same daisy chain should be the same. Baud rates of all devices in the daisy chain should be consistent with that of the SmartLogger, if communication with the SmartLogger is required.

----End



7 LCD

This topic describes the monitoring panel, monitoring menu, default page, and monitoring operations.

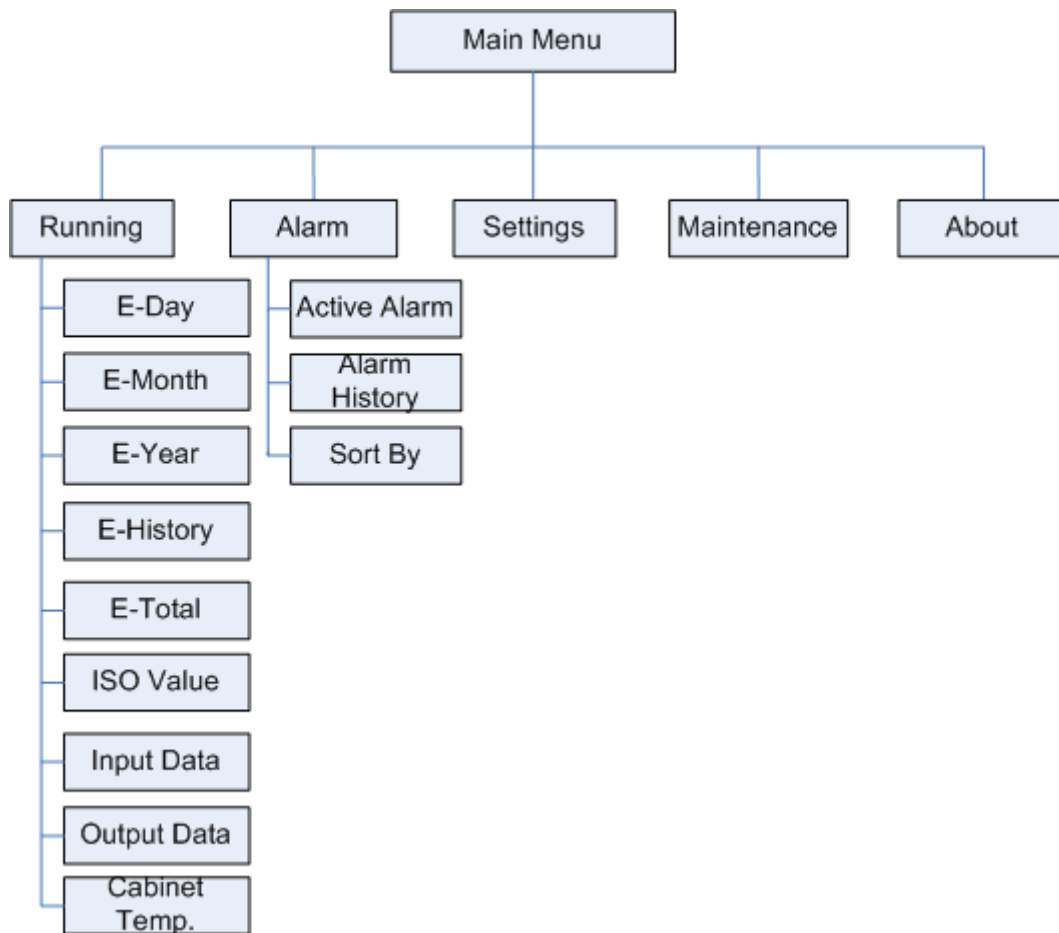
7.1 Monitoring Menu Hierarchy

This topic describes the monitoring menu hierarchy, which allows you to perform operations conveniently.

[Figure 7-1](#) shows the monitoring menu hierarchy.



Figure 7-1 Monitoring menu hierarchy (1)



The parameters vary depending on users (such as common user, advanced user, and special user). [Figure 7-2](#) and [Figure 7-3](#) show the hierarchy under the **Settings** and **Maintenance** menus.



NOTICE

The initial passwords for **Common User**, **Advanced User** and **Special User** are *000001*. Login inverter for the first time to use the initial password, and [change the password](#) as soon as possible to ensure account safety.

Figure 7-2 Monitoring menu hierarchy (2)

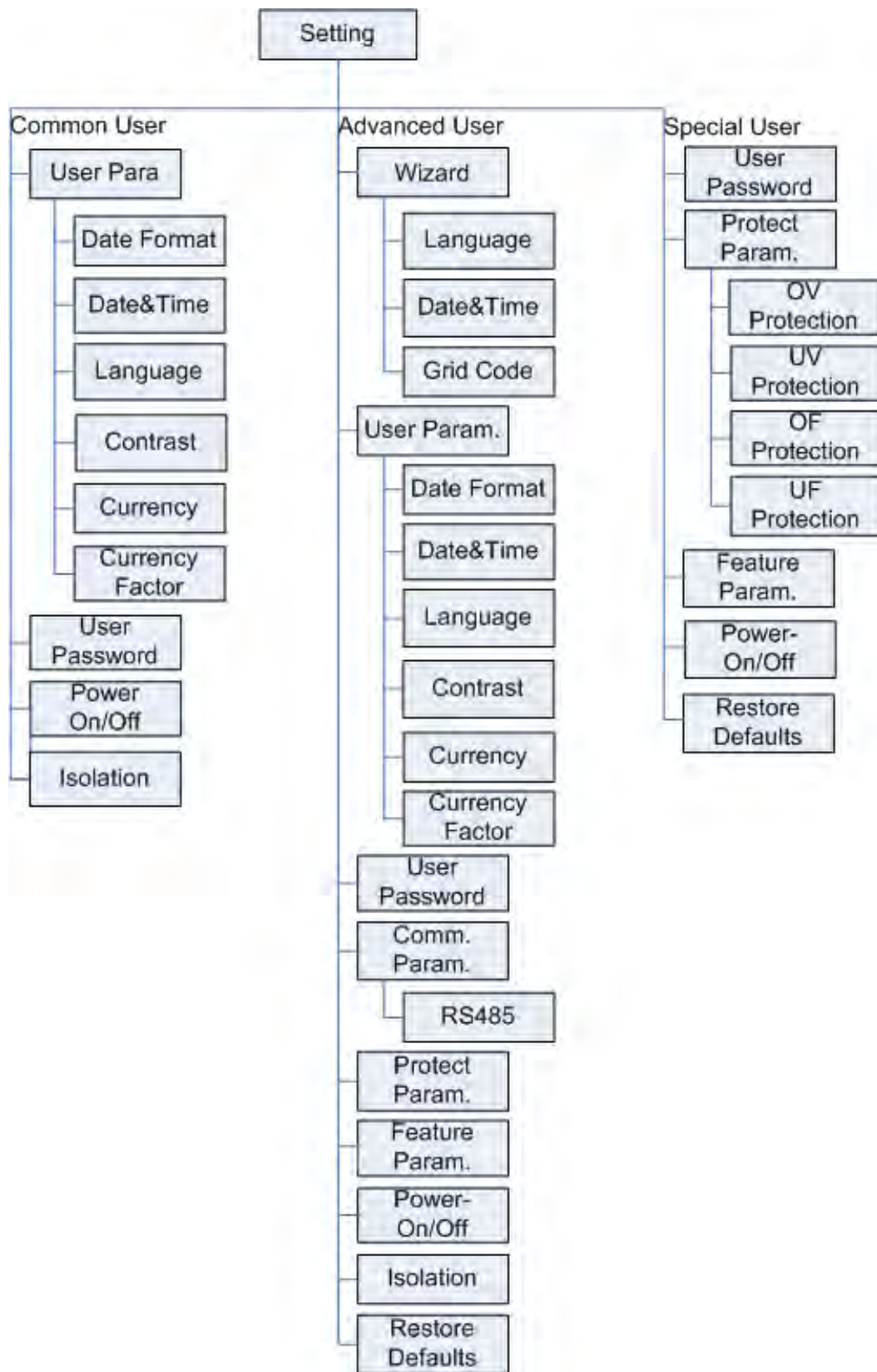
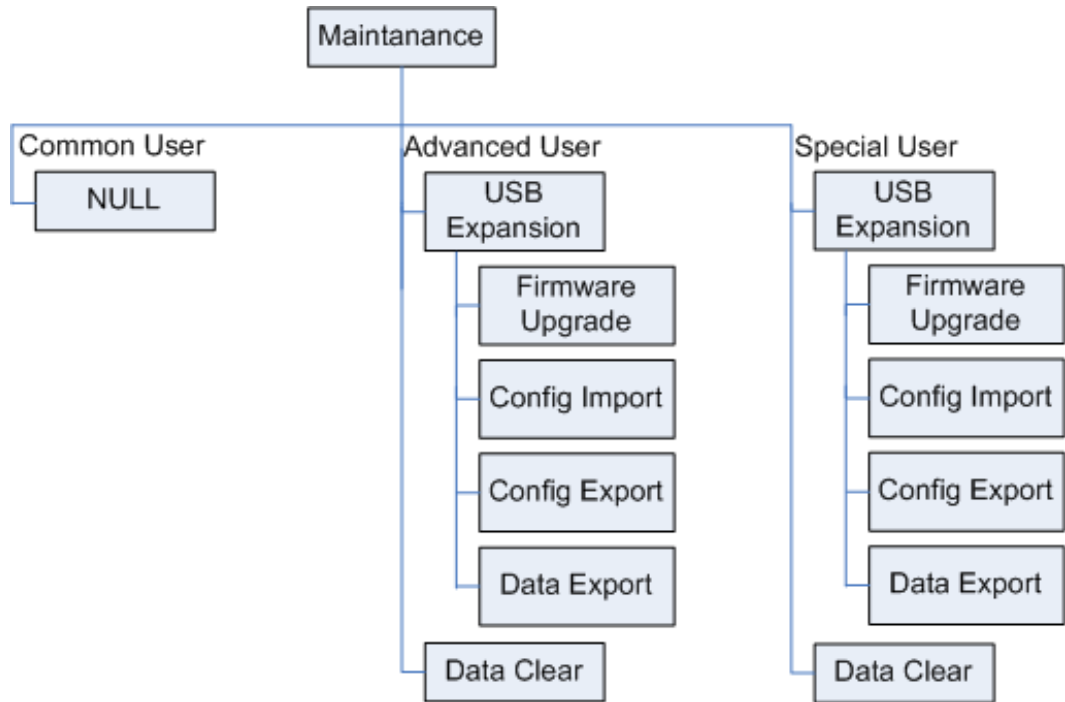


Figure 7-3 Monitoring menu hierarchy (3)



NOTE

Login inverter as a **Common User** because of permissions restrictions, there is no submenu under the **Maintenance** menu.

7.2 Monitoring Operations

This topic describes how to perform monitoring operations on the monitoring panel, such as viewing system operating information and setting user parameters.

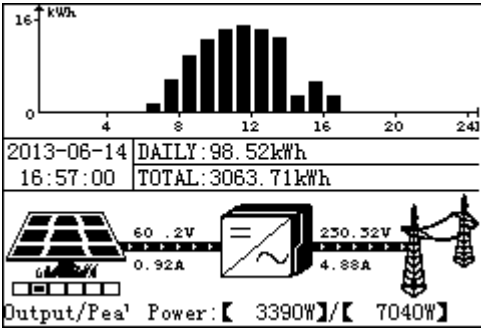

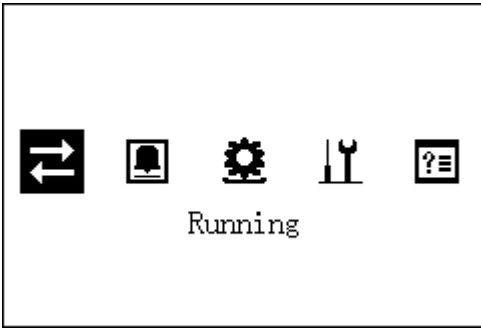


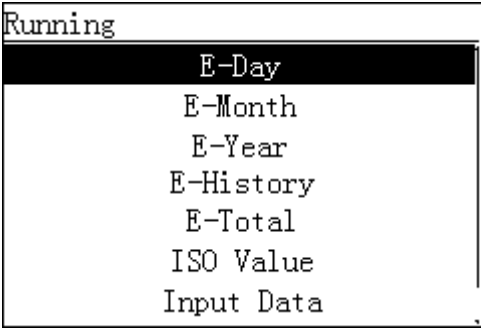


7.2.1 Viewing System Operating Information

This topic describes how to view the SUN2000 operating information on the monitoring panel. The operating information includes the daily energy yield, monthly energy yield, year energy yield, historical energy yield, total energy yield, ISO value, input data, output data, and the cabinet temperature.

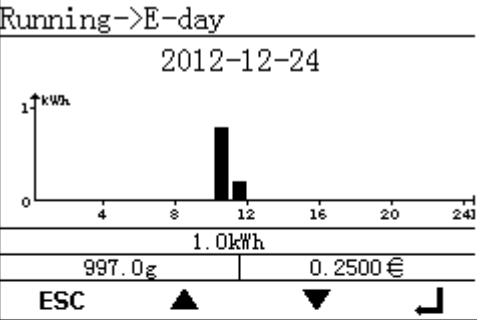
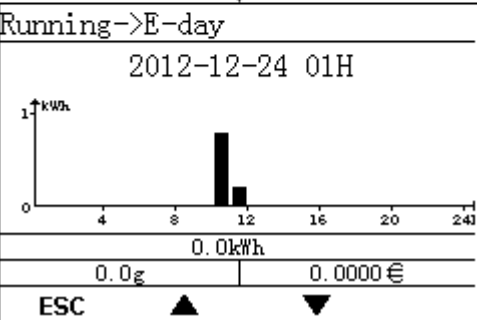






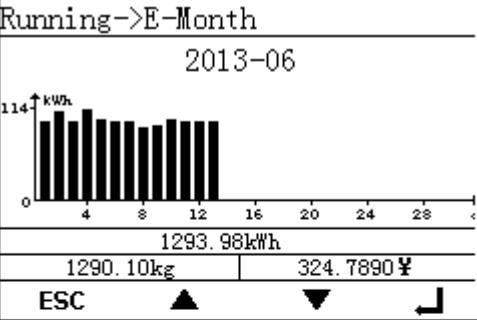
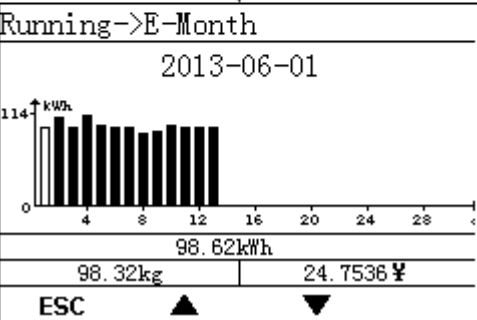



Procedure

- The following table describes the procedure for viewing system operating information. The parameter values in the figures are for reference only.

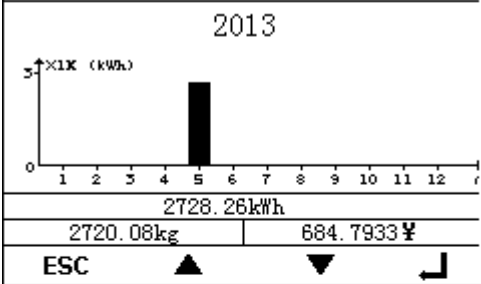
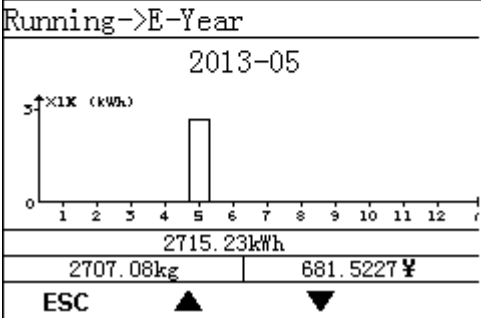


LCD	Operation Procedure
 <p>2013-06-14 DAILY: 98.52kWh 16:57:00 TOTAL: 3063.71kWh</p> <p>Output/Pea' Power: 【 3390W】/【 7040W】</p>	<p>1. On the default page, press  to enter the main menu.</p>
 <p>Running</p>	<p>2. Choose  and press .</p>
 <p>Running</p> <p>E-Day E-Month E-Year E-History E-Total ISO Value Input Data</p>	<p>3. Select an operating parameter by pressing  and click .</p> <p>The operating information includes the daily energy yield, monthly energy yield, year energy yield, historical energy yield, total energy yield, ISO value, input data, output data, and the cabinet temperature.</p>

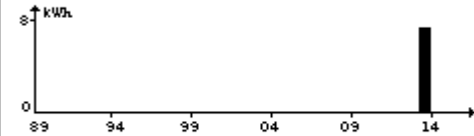
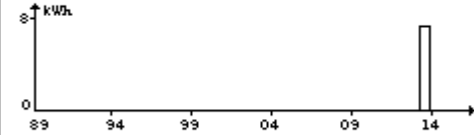





LCD	Operation Procedure
<p>Running->E-day</p> <p>2012-12-24</p>  <p>1.0kWh</p> <p>997.0g 0.2500€</p> <p>ESC ▲ ▼</p> <p>Running->E-day</p> <p>2012-12-24 01H</p>  <p>0.0kWh</p> <p>0.0g 0.0000€</p> <p>ESC ▲ ▼</p>	<p>4. View the daily energy yield.</p> <p>1. On the E-Day page, view the total energy yield and hourly energy yield on the current day.</p> <p>The displayed information includes the daily energy yield histogram, date, total energy yield on the current day, CO₂ emission reduction, and income corresponding to the energy yield.</p> <p>NOTE</p> <p>In the daily energy yield histogram, the horizontal ordinate stands for time (each block stands for one hour). The vertical coordinate stands for the energy yield (each block stands for the total energy yield during the last hour).</p> <p>2. Press  to view the energy yield of a specific hour on the current day.</p> <p>To switch between hours, press  or .</p> <p>NOTE</p> <p>The selected block is displayed in white.</p> <p>NOTICE</p> <p>To view the energy yield in the past 30 days (including the current day), press  or . To view the energy yield of a specific hour on the current day, press .</p>
<p>Running->E-Month</p> <p>2013-06</p>  <p>1293.98kWh</p> <p>1290.10kg 324.7890¥</p> <p>ESC ▲ ▼</p> <p>Running->E-Month</p> <p>2013-06-01</p>  <p>98.62kWh</p> <p>98.32kg 24.7536¥</p> <p>ESC ▲ ▼</p>	<p>5. View the monthly energy yield.</p> <p>1. On the E-Month page, view the total energy yield and daily energy yield on the current month.</p> <p>The displayed information includes the monthly energy yield histogram, date, total energy yield of the current month, CO₂ emission reduction, and income corresponding to the energy yield.</p> <p>NOTE</p> <p>In the monthly energy yield histogram, the horizontal ordinate stands for day (each block stands for one day). The vertical coordinate stands for the energy yield (each block stands for the total energy yield on that day).</p> <p>2. Press  to view the energy yield on a specific day of the current month.</p> <p>To switch between days, press  or .</p> <p>NOTE</p> <p>The selected block is displayed in white.</p> <p>NOTICE</p> <p>To view the energy yield in the past 12 months</p>

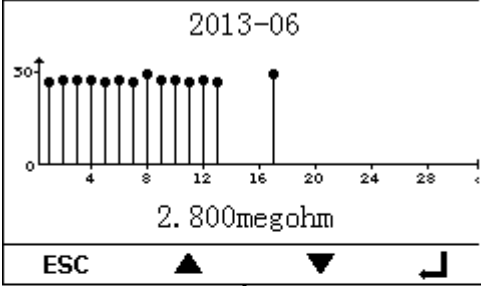
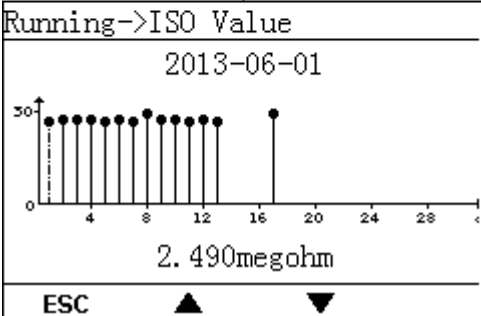


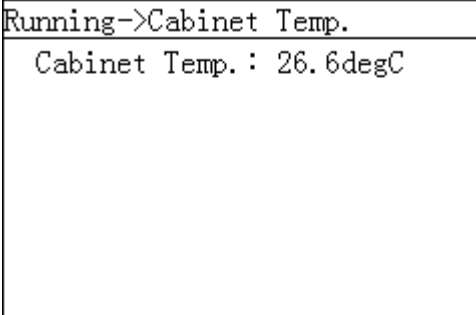
LCD	Operation Procedure
	(including the current month), press ▲ or ▼. To view the energy yield on a specific day of the current month, press ↵.
<p>Running->E-Year</p> 	<p>6. View the year energy yield.</p> <p>1. On the E-Year page, view the total energy yield and month energy yield on the current year.</p> <p>The displayed information includes the yearly energy yield histogram, date, total energy yield of the current year, CO₂ emission reduction, and income corresponding to the energy yield.</p>
<p>Running->E-Year</p> 	<p>NOTE</p> <p>In the yearly energy yield histogram, the horizontal ordinate stands for month (each block stands for one month). The vertical coordinate stands for the energy yield (each block stands for the total energy yield on that month).</p> <p>2. Press ↵ to view the energy yield on a specific month of the current year.</p> <p>To switch between months, press ▲ or ▼.</p>
	<p>NOTE</p> <p>The selected block is displayed in white.</p> <p>NOTICE</p> <p>To view the energy yield in the past 25 years (including the current year), press ▲ or ▼. To view the energy yield on a specific month of the current year, press ↵.</p>



LCD	Operation Procedure
<p>Running->E-History</p> <p>1989 - 2013</p>  <p>7.47kWh</p> <p>7.45kg 7.7933¥</p> <p>ESC</p> <p style="text-align: center;">↓</p> <p>Running->E-History</p> <p>2013</p>  <p>7.47kWh</p> <p>7.45kg 7.7933¥</p> <p>ESC</p>	<p>7. On E-History page, view the historical energy yields. The LCD will display the yearly energy yield histogram, time periods, total energy yield of the selected year, CO₂ emission reduction, and revenue corresponding to the CO₂ emission reduction. Data of the past 25 years (current year included) are available.</p> <p>NOTE</p> <p>In the historical energy yield histogram, the horizontal axis indicates time (by year), and the vertical axis indicates the energy yield. Each column indicates the total energy yield of a year.</p> <p>Press , then press  or  to view the energy yield of the selected year.</p>
<p>Running->E-Total</p> <p>Start Time:2013-05-01</p> <p>End Time:2013-06-17</p> <p>E-Total:2993.36kWh</p> <p>CO₂ Reduction:2984.38kg</p> <p>Gain:751.3334¥</p>	<p>8. On the E-Total page, view the total energy yield, CO₂ emission reduction, and revenue corresponding to the CO₂ emission reduction from the startup time to the current time.</p>



LCD	Operation Procedure
<p>Running->ISO Value</p> <p>2013-06</p>  <p>2.800megohm</p> <p>ESC ▲ ▼ ▸</p> <p>Running->ISO Value</p> <p>2013-06-01</p>  <p>2.490megohm</p> <p>ESC ▲ ▼</p>	<p>9. On the ISO Value page, view the day ISO value on the current month.</p> <p>To view the maximum insulation resistance detected when the SUN2000 connects to the power grid for the last time on each day of the current month, press ▸.</p>
<p>Running->Input Data</p> <p>PV1 V/I: 461.9V/1.60A</p> <p>PV2 V/I: 461.9V/0.63A</p> <p>PV3 V/I: 186.4V/0.03A</p> <p>PV4 V/I: 186.3V/0.00A</p> <p>PV5 V/I: 187.7V/0.05A</p> <p>PV6 V/I: 187.7V/0.00A</p>	<p>10. On the Input Data page, view the voltage and current of each PV input.</p>
<p>Running->Output Data</p> <p>Ua: 230.40V</p> <p>Ia: 4.86A</p> <p>Ub: 230.41V</p> <p>Ib: 4.87A</p> <p>Uc: 230.42V</p> <p>Ic: 4.88A</p> <p>Active power: 3390W</p> <p>The display page of the SUN2000-8KTL to SUN2000-23KTL is taken as an example.</p>	<p>11. On the Output Data page, view the phase voltage, output current, power, frequency, and power factor of each phase.</p> <p>NOTE</p> <p>As the SUN2000-28KTL has three-phase, three-wire outputs, the output voltage and current are line voltage and line current.</p>

LCD	Operation Procedure
	<p>12. On the Cabinet Temp. page, view the temperature of the input SUN2000.</p>

---End

7.2. Viewing Alarm Records

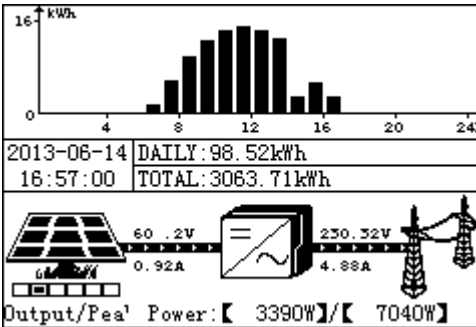

This topic describes how to view active and historical alarm records and set the alarm record sort mode on the monitoring panel.

Context

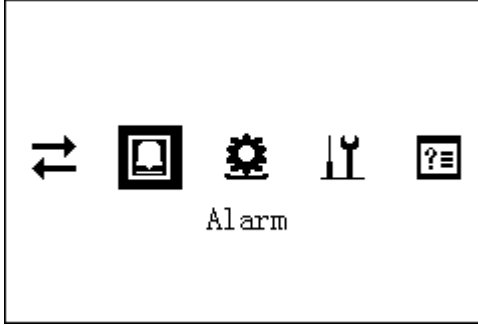





The liquid crystal display (LCD) can display a maximum of 800 latest alarm records.

Procedure


- The following table describes the procedure for viewing active alarms and historical alarms and setting the alarm record sort mode. The parameter values in the figures are for reference only.

LCD	Operation Procedure
	<p>1. On the default page, press  to enter the main menu.</p>



LCD	Operation Procedure
	<p>2. Choose  and press .</p>
<p>Alarm</p> <pre>Active Alarm(0) Alarm History(1) Sort By</pre>	<p>3. Select a menu by pressing , and view alarm details, clear an alarm, or set the alarm record sort mode by pressing .</p> <ul style="list-style-type: none"> • To view active alarms, go to step 4. • To view historical alarms, go to step 5. • To set the alarm record sort mode, go to step 6.
<pre>Alarm->Active alarm(1/3) ①Fan Fault ①Surge Arrester Fault ①Version Mismatch</pre> <p style="text-align: center;">↓</p> <pre>Fan Fault(1/3) Alarm ID:320 Severity:Minor ① occur:2012-12-27 15:07:23 Info: Error Code = 0x00000001</pre>	<p>4. On the Active Alarm (A/B) page, select an alarm record, and press  to view the alarm details.</p> <p>The alarm details include the alarm ID, alarm severity, occurrence time, location information, and reason ID.</p> <p>A stands for the sequence of the alarm in the active alarm list. B stands for the total number of active alarms.</p>



LCD	Operation Procedure
<pre>Alarm->Alarm History(1/1) ①Sting 1 Abnormal/ID:1</pre> <p style="text-align: center;">↓</p> <pre>Sting 1 Abnormal(1/1) Alarm ID:106 Severity:Warning ① Generate:2013-04-28 18:36:08 Clear:2013-04-28 21:33:44 Info: Reason ID = 1</pre>	<p>5. On the Alarm History (A/B) page, select an alarm record, and press  to view the alarm details.</p> <p>The alarm details include the alarm ID, alarm severity, termination time, location information, and reason ID.</p> <p>A stands for the sequence of the alarm in the historical alarm list. B stands for the total number of historical alarms.</p>
<pre>Alarm Active Alarm(0) Alarm History(1) Sort By</pre> <p style="text-align: center;">↓</p> <pre>Alarm Sort By By Generation Time ✓ By Alarm Severity</pre>	<p>6. On the Sort By page, select By Generation Time or By Alarm Severity.</p>

----End

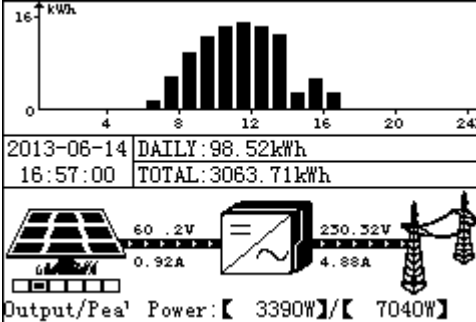

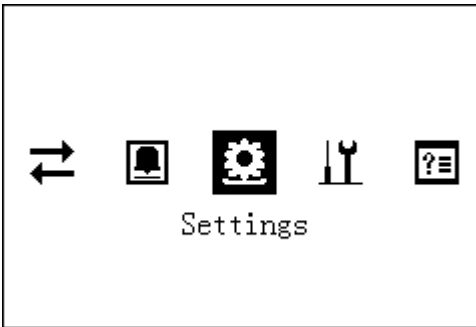


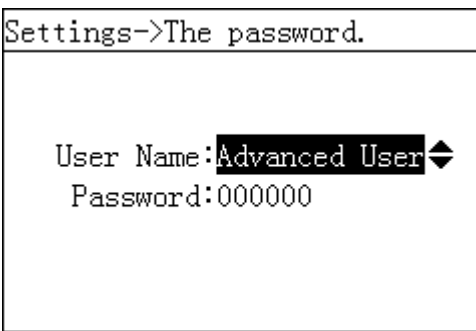



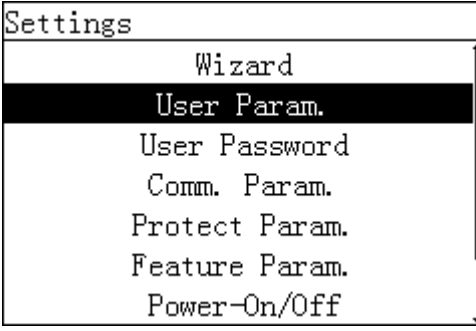

7.2. Setting System Time Parameters

This topic describes how to set the time and date for the SUN2000 on the monitoring panel.










Procedure

- The following table describes the procedure for setting the time and date. The parameter values in the figures are for reference only.

LCD	Operation Procedure
	<p>1. On the default page, press  to enter the main menu.</p>
	<p>2. Choose  and press .</p>
<p>Settings->The password.</p> 	<p>3. Enter the user name and password by pressing  or , and press .</p> <p>NOTE</p> <ul style="list-style-type: none"> The selectable user names are Common User or Advanced User. The initial password for Common User and Advanced User is 000001. If you forget the password, contact JDA technical support for a dynamic password that is effective only on the current day. Change the password after login. After the authentication is successful, the system keeps the authentication information for 30 seconds. If you exit from the Settings page and log in again within 30 seconds, no authentication is required.
<p>Settings</p>  <p>Log in to the SUN2000 as Advanced</p>	<p>4. Choose User Param., and press .</p>



LCD	Operation Procedure
<p>User.</p>	
<pre>Settings->User Param. Date Format Date&Time Language Contrast Currency Currency Factor</pre>	<p>5. Choose Date Format or Date&Time by pressing , and press </p>
<pre>Settings->User Param. Date Format Date&Time Language Contrast Currency Currency Factor</pre>	
<pre>Settings->User Param. Date Format YYYY-MM-DD MM-DD-YYYY DD-MM-YYYY</pre>	<p>6. On the Date Format page, select a date format, and press .</p> <p>The selectable date formats include YYYY-MM-DD, MM-DD-YYYY and DD-MM-YYYY. YYYY, MM, and DD stand for year, month, and day respectively.</p>
<pre>Settings->User Param. Date&Time Date:2013-06-17 Time:09:42:17</pre>	<p>7. On the Date&Time page, set the date and time, and press .</p> <ul style="list-style-type: none"> To select the parameter, click . To set the parameter value, set  or . The date and time are displayed in the formats of YYYY-MM-DD and hh-mm-ss respectively. hh, mm, and ss stand for hour, minute, and second respectively.

---End

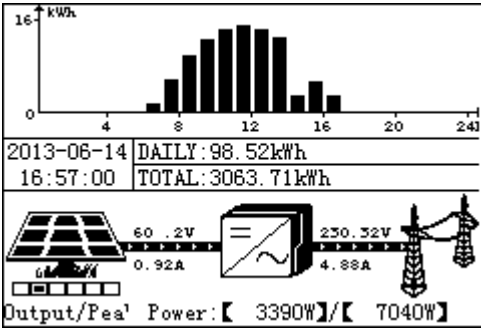

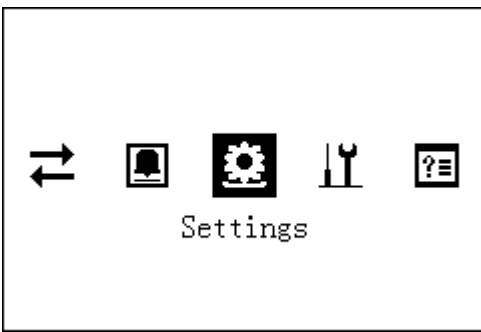


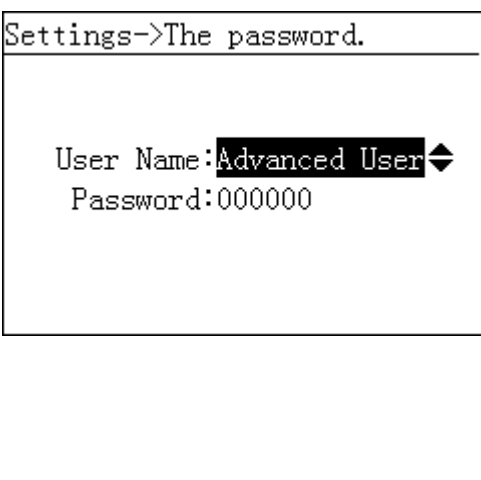




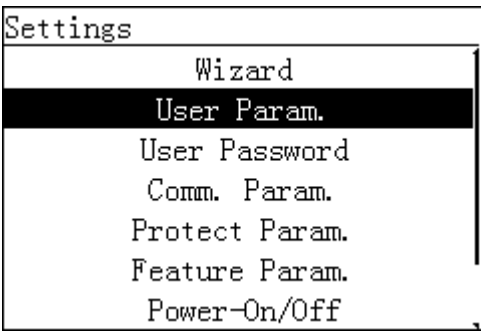

7.2.4 Setting the System Language

This topic describes how to set the SUN2000 display language on the monitoring panel.



Procedure

- The following table describes the procedure for setting the display language. The parameter values in the figures are for reference only.

LCD	Operation Procedure
 <p>2013-06-14 DAILY: 98.52kWh 16:57:00 TOTAL: 3063.71kWh</p> <p>Output/Pea' Power: 【 3390W】/【 7040W】</p>	<p>1. On the default page, press  to enter the main menu.</p>
 <p>Settings</p>	<p>2. Choose  and press .</p>
<p>Settings->The password.</p>  <p>User Name: Advanced User  Password: 000000</p>	<p>3. Enter the user name and password by pressing  or , and press .</p> <p>NOTE</p> <ul style="list-style-type: none"> The selectable user names are Common User or Advanced User. The initial password for Common User and Advanced User is 000001. If you forget the password, contact JDA technical support for a dynamic password that is effective only on the current day. Change the password after login. After the authentication is successful, the system keeps the authentication information for 30 seconds. If you exit from the Settings page and log in again within 30 seconds, no authentication is required.
 <p>Settings</p> <p>Wizard User Param. User Password Comm. Param. Protect Param. Feature Param. Power-On/Off</p> <p>Log in to the SUN2000 as Advanced</p>	<p>4. Choose User Param., and press .</p>



LCD	Operation Procedure
User. Settings->User Param. Date Format Date&Time Language Contrast Currency Currency Factor	5. Choose Language by pressing ▼, and press ↵.
Settings->User Param. Language English ✓ 中文 Deutsch Italiano Français Polski	6. On the Language page, select a display language, and press ↵. The pages will be displayed in the selected language.

---End

7.2.5 Setting the Contrast

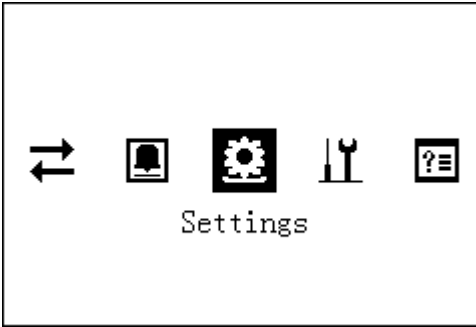


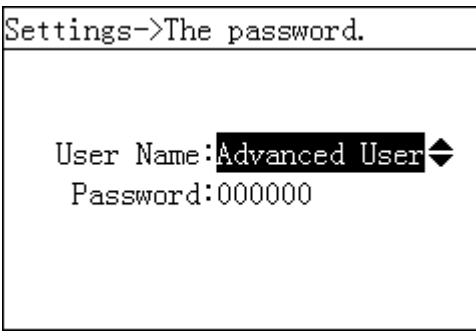



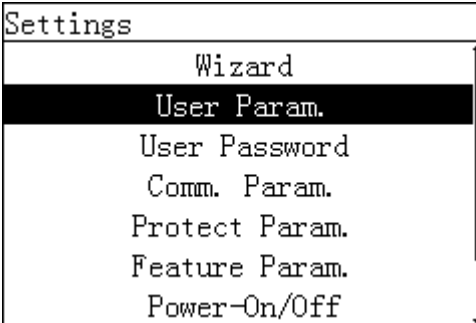

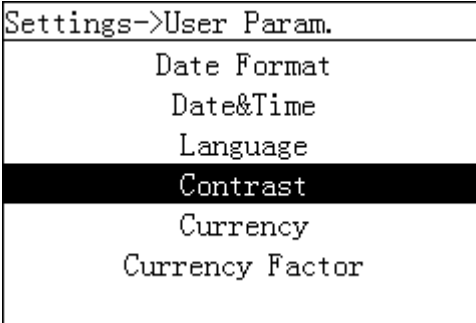


This topic describes how to set the SUN2000 contrast on the monitoring panel.

Procedure

- The following table describes the procedure for setting the contrast. The parameter values in the figures are for reference only.

LCD	Operation Procedure
	1. On the default page, press ↵ to enter the main menu.



LCD	Operation Procedure
 <p style="text-align: center;">Settings</p>	<p>2. Choose  and press .</p>
<p>Settings->The password.</p>  <p>User Name: Advanced User ◆ Password: 000000</p>	<p>3. Enter the user name and password by pressing  or , and press .</p> <p>NOTE</p> <ul style="list-style-type: none"> • The selectable user names are Common User or Advanced User. The initial password for Common User and Advanced User is 000001. If you forget the password, contact JDA technical support for a dynamic password that is effective only on the current day. Change the password after login. • After the authentication is successful, the system keeps the authentication information for 30 seconds. If you exit from the Settings page and log in again within 30 seconds, no authentication is required.
<p>Settings</p>  <p>Wizard User Param. User Password Comm. Param. Protect Param. Feature Param. Power-On/Off</p> <p>Log in to the SUN2000 as Advanced User.</p>	<p>4. Choose User Param., and press .</p>
<p>Settings->User Param.</p>  <p>Date Format Date&Time Language Contrast Currency Currency Factor</p>	<p>5. Choose Contrast by pressing , and press .</p>

LCD	Operation Procedure
	<p>6. On the Contrast tab, press ▲ and ▼ to set the contrast.</p> <p>The pages will be displayed in the selected language.</p>

----End

7.2.6 Setting the Currency and Currency Factor

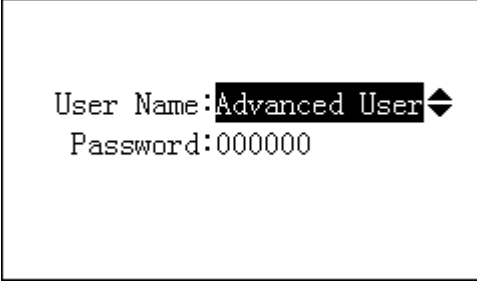
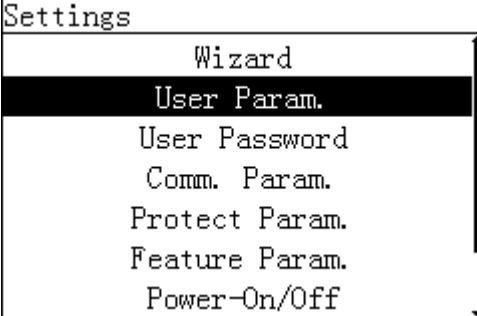
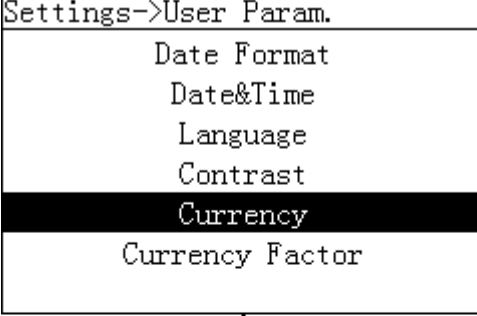
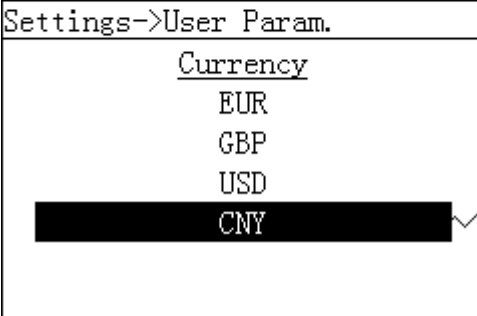
This topic describes how to set the currency and the revenue per kilowatt hour, which allows you to calculate the revenue corresponding to the energy yield.

Procedure

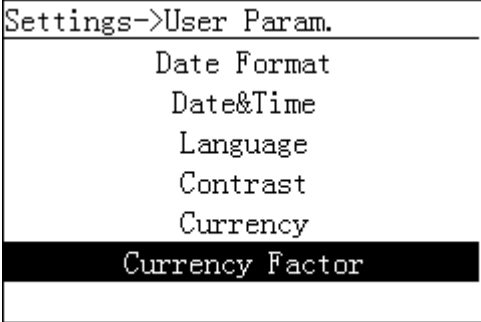
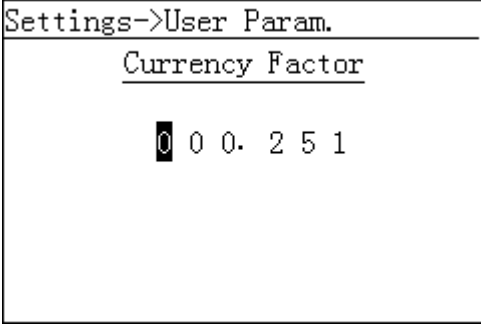
- The following table describes the procedure for setting the currency and currency factor. The parameter values in the figures are for reference only.

LCD	Operation Procedure
	<p>1. On the default page, press to enter the main menu.</p>
	<p>2. Choose and press .</p>



LCD	Operation Procedure
<p>Settings->The password.</p> 	<p>3. Enter the user name and password by pressing or , and press .</p> <p>NOTE</p> <ul style="list-style-type: none"> The selectable user names are Common User or Advanced User. The initial password for Common User and Advanced User is 000001. If you forget the password, contact JDA technical support for a dynamic password that is effective only on the current day. Change the password after login. After the authentication is successful, the system keeps the authentication information for 30 seconds. If you exit from the Settings page and log in again within 30 seconds, no authentication is required.
<p>Settings</p>  <p>Log in to the SUN2000 as Advanced User.</p>	<p>4. Choose User Param., and press .</p>
<p>Settings->User Param.</p>  <p style="text-align: center;">↓</p> <p>Settings->User Param.</p> 	<p>5. Set the currency.</p> <ol style="list-style-type: none"> Select Currency by pressing , and press . Select a currency, and press . <p>The selectable currencies include EUR, GBP, USD, and CNY.</p>



LCD	Operation Procedure
 <p>Settings->User Param. Date Format Date&Time Language Contrast Currency Currency Factor</p> <p>↓</p>  <p>Settings->User Param. Currency Factor 000.251</p>	<p>6. Set the currency factor.</p> <p>NOTE The currency factor is the local electricity price.</p> <ol style="list-style-type: none"> 1. Select Currency Factor by pressing ▼, and press ↵. 2. Set the currency factor by pressing ▲ or ▼, and press ↵.

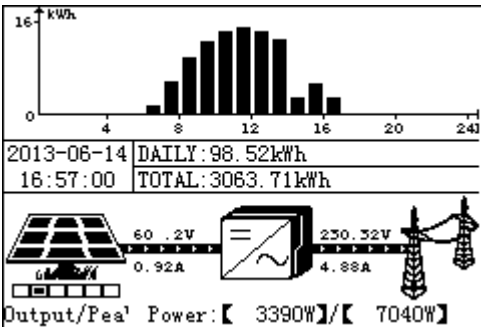
----End

7.2. Changing a Password

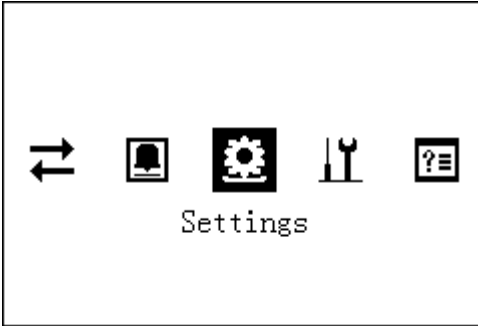


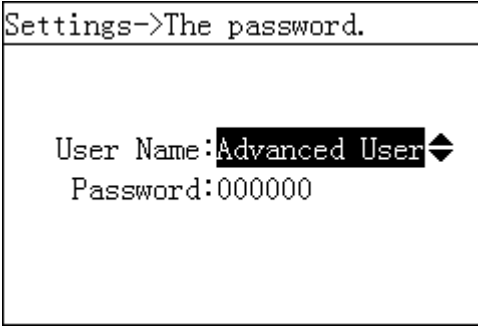



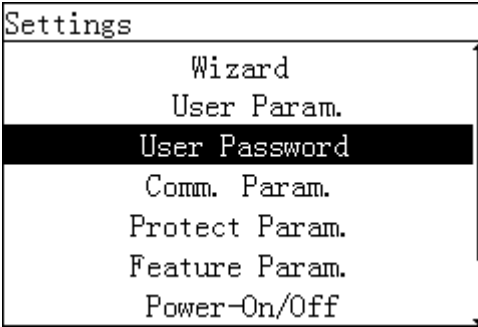


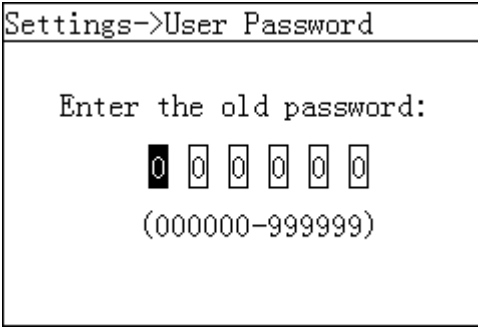




This topic describes how to change a password on the monitoring panel.

Procedure







- The following table describes the procedure for setting a new password. The parameter values in the figures are for reference only.

LCD	Operation Procedure
 <p>16 kWh 0 4 8 12 16 20 24h</p> <p>2013-06-14 DAILY: 98.52kWh 16:57:00 TOTAL: 3063.71kWh</p> <p>60.2V 0.92A 230.32V 4.88A</p> <p>Output/Pea' Power: 【 3390W】/【 7040W】</p>	<ol style="list-style-type: none"> 1. On the default page, press ↵ to enter the main menu.



LCD	Operation Procedure
 <p style="text-align: center;">Settings</p>	<p>2. Choose  and press .</p>
<p>Settings->The password.</p> 	<p>3. Enter the user name and password by pressing  or , and press .</p> <p>NOTE</p> <ul style="list-style-type: none"> The user name can be set to Common User, Advanced User, and Special User. The initial password for Common User, Advanced User, and Special User is <i>000001</i>. If you forget the password, contact JDA technical support for a dynamic password that is effective only on the current day. Change the password after login. After the authentication is successful, the system keeps the authentication information for 30 seconds. If you exit from the Settings page and log in again within 30 seconds, no authentication is required.
<p>Settings</p> 	<p>4. Choose User Password by pressing , and press .</p>
<p>Settings->User Password</p> 	<p>5. Enter the old password and press .</p> <p>Increase or decrease the value by pressing  or . Switch between data bits by pressing .</p>



LCD	Operation Procedure
<p>Settings->User Password</p> <hr/> <p>Enter a new password:</p> <p>0 0 0 0 0 0</p> <p>(000000-999999)</p>	<p>6. Enter a new password and press .</p> <p>Increase or decrease the value by pressing  or . Switch between data bits by pressing .</p>
<p>Settings->User Password</p> <hr/> <p>Enter the new password again:</p> <p>0 0 0 0 0 0</p> <p>(000000-999999)</p> <p style="text-align: center;">↓</p> <hr/> <p>Settings->User Password</p> <hr/> <p>Password changed successfully</p> <hr/> <p style="text-align: right;">:Enter</p>	<p>7. Enter the new password again and press .</p> <p>NOTE</p> <p>Ensure that the confirm password is the same as the new password. otherwise, an error message will be displayed.</p> <p>After password changing is complete, the LCD displays a message, displaying that the operation is successful.</p>

----End

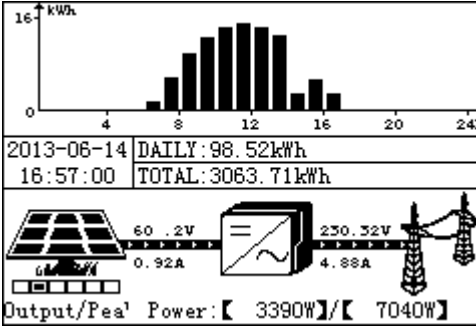

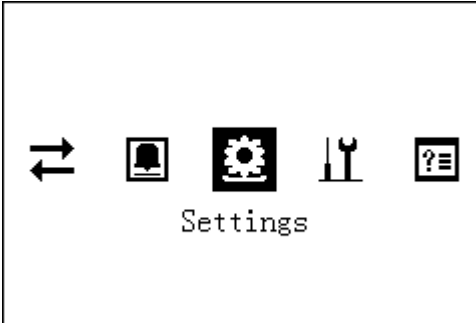


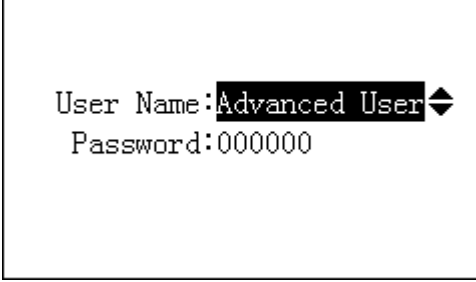



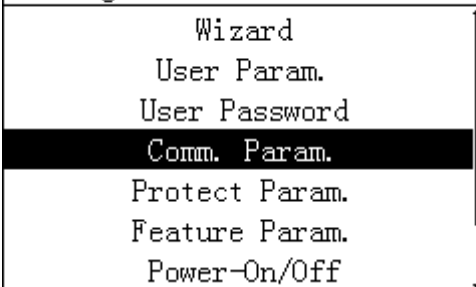

7.2.8 Setting Communications Parameters

This topic describes how to set RS485 communications parameters, including the address, protocol, baud rate, and check mode.

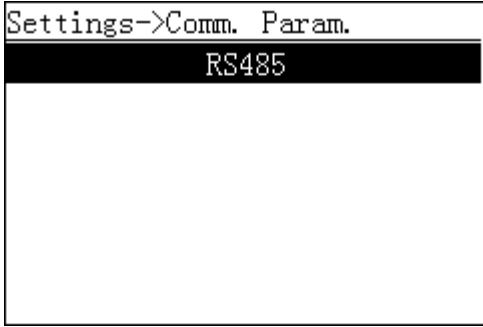

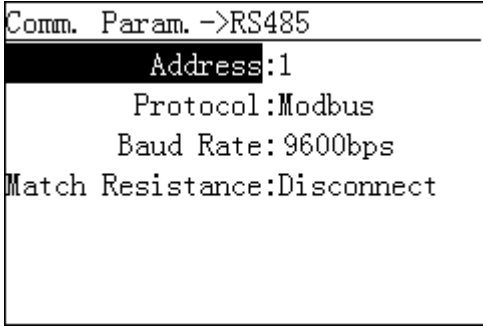

Procedure

- The following table describes the procedure for setting communications parameters. The parameter values in the figures are for reference only.



LCD	Operation Procedure
	<p>1. On the default page, press  to enter the main menu.</p>
	<p>2. Choose  and press .</p>
<p>Settings->The password.</p> 	<p>3. Enter the user name and password by pressing  or , and press .</p> <p>NOTE</p> <ul style="list-style-type: none"> • The selectable user name is Advanced User. The initial passwords for Advanced User is <i>000001</i>. If you forget the password, contact JDA technical support for a dynamic password that is effective only on the current day. Change the password after login. • After the authentication is successful, the system keeps the authentication information for 30 seconds. If you exit from the Settings page and log in again within 30 seconds, no authentication is required.
<p>Settings</p> 	<p>4. Choose Comm. Param., and press .</p>



LCD	Operation Procedure
	<p>5. On the Comm. Param. page, press .</p>
	<p>6. Set Address, Protocol, Baud Rate, and Match Resistance, and press .</p> <ul style="list-style-type: none"> • The selectable display addresses include 1 to 63. • The selectable display protocol is Modbus. • The selectable display baud rates include 4800bps, 9600bps, and 19200bps. • The selectable display status of the match resistance include Disconnect and Connect. <p>This parameter is set to Disconnect by default. If signals are distorted or the communication is of poor quality because the signal cable is too long, set the parameter to Connect.</p>

----End

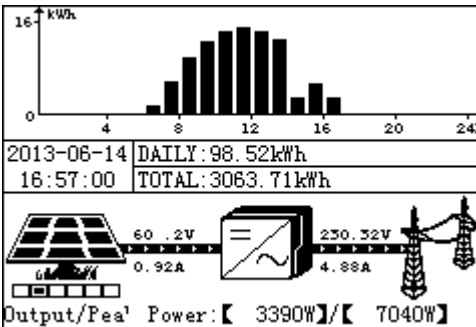

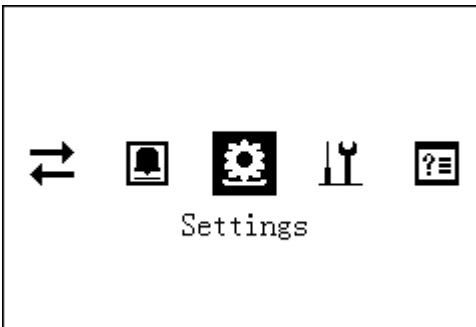


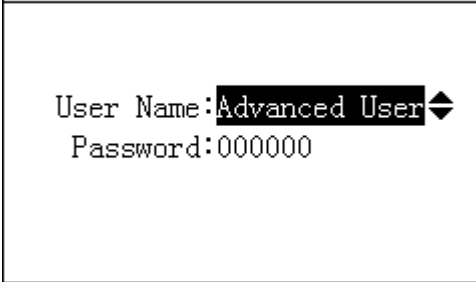



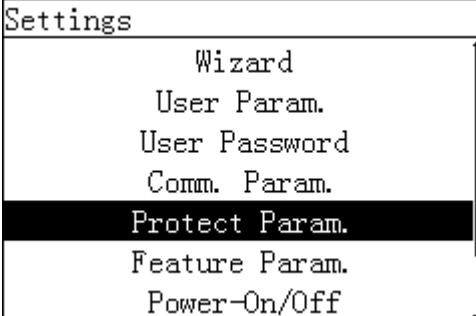

7.2.9 Setting Protection Parameters

This topic describes how to set SUN2000 protection parameters on the monitoring panel.

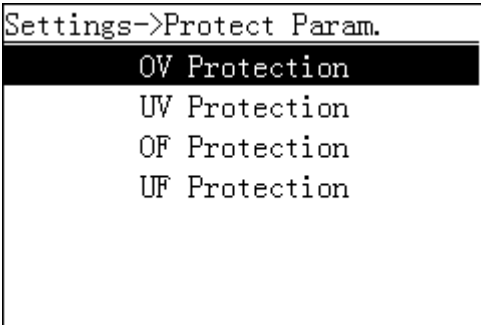

Procedure

- The following table describes the procedure for setting protection parameters. The parameter values in the figures are for reference only.



LCD	Operation Procedure
 <p>2013-06-14 DAILY: 98.52kWh 16:57:00 TOTAL: 3063.71kWh</p> <p>Output/Peak Power: 【 3390W】/【 7040W】</p>	<p>1. On the default page, press  to enter the main menu.</p>
 <p>Settings</p>	<p>2. Choose  and press .</p>
<p>Settings->The password.</p>  <p>User Name: Advanced User ◀▶ Password: 000000</p>	<p>3. Enter the user name and password by pressing  or , and press .</p> <p>NOTE</p> <ul style="list-style-type: none"> The selectable user names are Advanced User and Special User. The initial password for Advanced User and Special User is 000001. If you forget the password, contact JDA technical support for a dynamic password that is effective only on the current day. Change the password after login. After the authentication is successful, the system keeps the authentication information for 30 seconds. If you exit from the Settings page and log in again within 30 seconds, no authentication is required.
<p>Settings</p>  <p>Wizard User Param. User Password Comm. Param. Protect Param. Feature Param. Power-On/Off</p> <p>Log in to the SUN2000 as Advanced User.</p>	<p>4. Choose Protect Param. and press .</p> <ul style="list-style-type: none"> If you log in to the SUN2000 as Advanced User, perform step 5. If you log in to the SUN2000 as Special User, perform step 6.



LCD	Operation Procedure
 <p>The preceding figure is displayed if you have logged in to the SUN2000 as Advanced User.</p>	<p>5. Select a parameter, and press .</p>

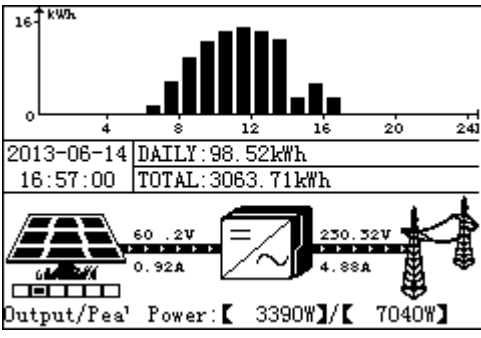

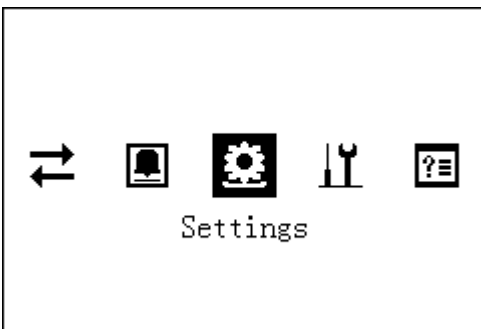


----End

7.2.10 Setting Feature Parameters

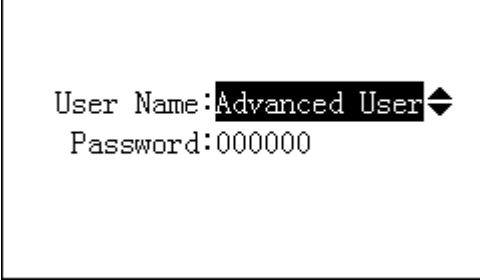





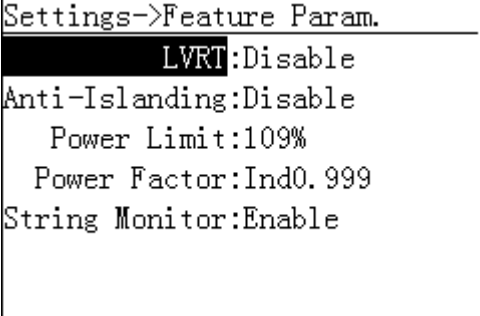

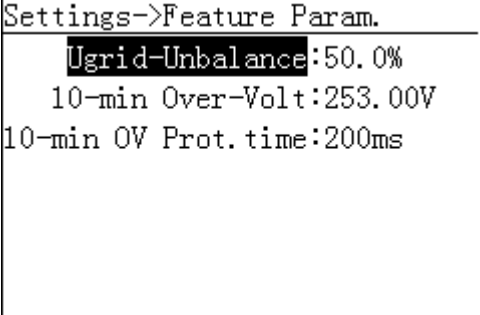

This topic describes how to set SUN2000 feature parameters on the monitoring panel.

Procedure

- The following table describes the procedure for setting feature parameters. The parameter values in the figures are for reference only.

LCD	Operation Procedure
	<p>1. On the default page, press  to enter the main menu.</p>
	<p>2. Choose  and press .</p>



LCD	Operation Procedure
<p>Settings->The password.</p> 	<p>3. Enter the user name and password by pressing  or , and press .</p> <p>NOTE</p> <ul style="list-style-type: none"> The selectable user names are Advanced User and Special User. The initial password for Advanced User and Special User is 000001. If you forget the password, contact JDA technical support for a dynamic password that is effective only on the current day. Change the password after login. After the authentication is successful, the system keeps the authentication information for 30 seconds. If you exit from the Settings page and log in again within 30 seconds, no authentication is required.
<p>Settings</p>  <p>Log in to the SUN2000 as Advanced User.</p>	<p>4. Choose Feature Param. and press .</p> <ul style="list-style-type: none"> If you log in to the SUN2000 as Advanced User, perform step 5 only. If you log in to the SUN2000 as Special User, perform step 6 only.
<p>Settings->Feature Param.</p>  <p>The preceding figure is displayed if you have logged in to the SUN2000 as Advanced User.</p>	<p>5. Set LVRT, Anti-Islanding, Power Limit, Power Factor, String Monitor, and press .</p> <p>If the String Monitor is enabled, the SUN2000 monitors the operating status of all the connected PV strings in real time. If the operating status is abnormal, warnings are generated to remind customers to rectify the fault (components are shielded for a long time, or components are faulty) in time.</p>
<p>Settings->Feature Param.</p> 	<p>6. Set Ugrid-Unbalance, 10-min Over-Vout, and 10-min OV Prot.time, and press .</p> <p>According to the difference of current Grid Code choice, the parameters are different.</p>



LCD	Operation Procedure
The preceding figure is displayed if you have logged in to the SUN2000 as Special User .	

----End

7.2.11 Setting Isolation Parameters

This topic describes how to set SUN2000 isolation parameters on the monitoring panel.

Context



NOTICE

To ground PV arrays, install a three-phase four-wire isolation transformer and the parameter of **Isolation** is set to **Input Grounded, With TF**.

Procedure

- The following table describes the procedure for setting isolation parameters. The parameter values in the figures are for reference only.

LCD	Operation Procedure
	1. On the default page, press to enter the main menu.
	2. Choose and press .



LCD	Operation Procedure
	<p>3. Enter the user name and password by pressing or , and press .</p> <p>NOTE</p> <ul style="list-style-type: none"> The selectable user names are Common User and Advanced User. The initial password for Common User and Advanced User is <i>000001</i>. If you forget the password, contact JDA technical support for a dynamic password that is effective only on the current day. Change the password after login. After the authentication is successful, the system keeps the authentication information for 30 seconds. If you exit from the Settings page and log in again within 30 seconds, no authentication is required.
	<p>4. Choose Isolation and press .</p>
	<p>5. Select one isolation method, and press .</p>

----End

7.2.1 Enabling Manual Power -On and Power -Off

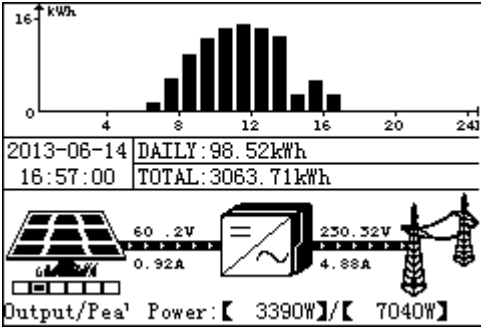

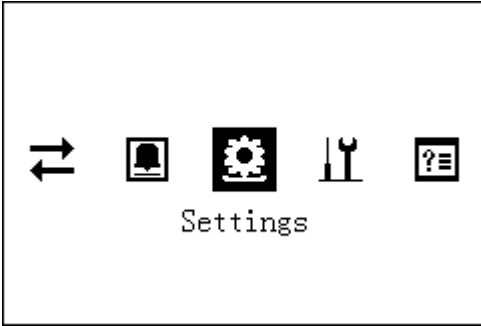


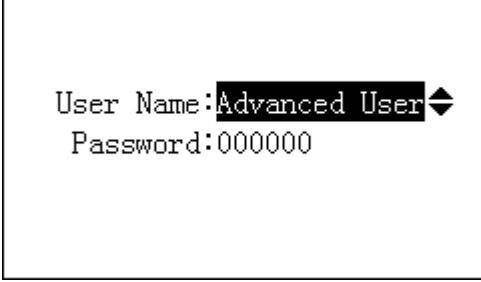





This topic describes how to enable manual power-on and power-off on the monitoring panel.

Procedure

- The following table describes the procedure for enabling manual power-on and power-off. The parameter values in the figures are for reference only.

LCD	Operation Procedure
-----	---------------------



LCD	Operation Procedure
	<p>1. On the default page, press  to enter the main menu.</p>
	<p>2. Choose  and press .</p>
<p>Settings->The password.</p> 	<p>3. Enter the user name and password by pressing  or , and press .</p> <p>NOTE</p> <ul style="list-style-type: none"> The user name can be set to Common User, Advanced User, and Special User. The initial password for Common User, Advanced User, and Special User is <i>000001</i>. If you forget the password, contact JDA technical support for a dynamic password that is effective only on the current day. Change the password after login. After the authentication is successful, the system keeps the authentication information for 30 seconds. If you exit from the Settings page and log in again within 30 seconds, no authentication is required.
<p>Settings</p>  <p>Log in to the SUN2000 as Advanced User.</p>	<p>4. Choose Power-On/Off, and press .</p> <ul style="list-style-type: none"> If you want to enable manual power-on, go to step 5. If you want to enable manual power-off, go to step 6.



LCD	Operation Procedure
<pre> Settings->Power-On/Off Power-On Power-Off </pre> <p style="text-align: center;">↓</p> <pre> Power-On/Off->Power-On Power on? ESC:Cancel ↵:Enter </pre>	<p>5. Enable manual power-on.</p> <ol style="list-style-type: none"> 1. Choose Power-On and press ↵. 2. Enter ↵ again to confirm your settings.
<pre> Settings->Power On/Off Power On Power Off </pre> <p style="text-align: center;">↓</p> <pre> Power-On/Off->Power-Off Power off? ESC:Cancel ↵:Enter </pre>	<p>6. Enable manual power-off.</p> <ol style="list-style-type: none"> 1. Choose Power-Off, and press ↵. 2. Enter ↵ again to confirm your settings.

----End

7.2.1 Restoring Factory Settings

This topic describes how to restore factory settings for the SUN2000 on the monitoring panel. After restoring factory settings is complete, all parameters except the current date and time will restore the default factory settings. However, the operating information, alarm records, and system logs do not change.

Context



NOTICE

- Perform this operation with caution because all parameters except the current date and time will restore to factory settings!
- To ground PV arrays, install a three-phase four-wire isolation transformer and the parameter of **Isolation** is set to **Input Grounded, With TF**.

Procedure

- The following table describes the procedure for restoring factory settings. The parameter values in the figures are for reference only.

LCD	Operation Procedure
	<p>1. On the default page, press to enter the main menu.</p>
	<p>2. Choose and press .</p>



LCD	Operation Procedure
<p>Settings->The password.</p> <hr/> <p>User Name:Advanced User↔ Password:000000</p>	<p>3. Enter the user name and password by pressing or , and press ↵.</p> <p>NOTE</p> <ul style="list-style-type: none"> • The selectable user names are Advanced User and Special User. The initial password for Advanced User and Special User is 000001. If you forget the password, contact JDA technical support for a dynamic password that is effective only on the current day. Change the password after login. • After the authentication is successful, the system keeps the authentication information for 30 seconds. If you exit from the Settings page and log in again within 30 seconds, no authentication is required.
<p>Settings</p> <hr/> <p>User Password Comm. Param. Protect Param. Feature Param. Power-On/Off Isolation Restore Defaults</p> <p>Log in to the SUN2000 as Advanced User.</p>	<p>4. Choose Restore Defaults, and press ↵.</p>
<p>Settings->Restore Defaults</p> <hr/> <p>Restore defaults? ESC:Cancel ↵:Enter</p>	<p>5. On the displayed page, press ↵.</p>
<p>Settings->Restore Defaults</p> <hr/> <p>Complete.</p> <p>↵:Enter</p>	<p>6. Press ↵ to complete the settings.</p> <p>NOTE</p> <p>After restoring factory settings, the menu is displayed in English, and then the LCD switch to the Wizard.</p>

----End

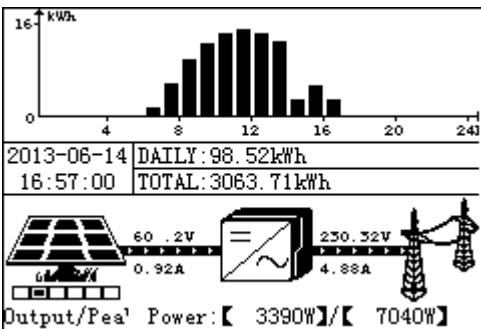

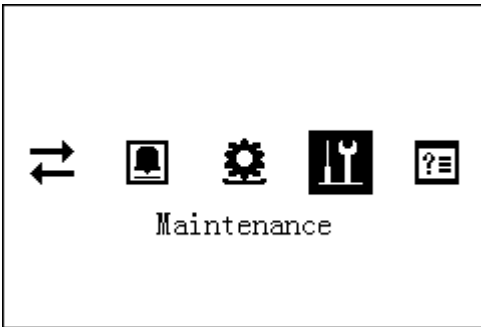


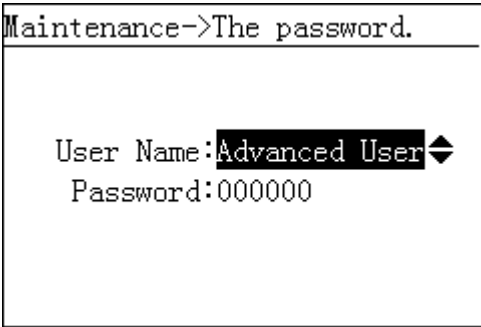





7.2.14 Cleaning the UserData

This topic describes how to clean the system operating information and the historical alarms for the SUN2000.

Procedure

- The following table describes the procedure for cleaning the user data. The parameter values in the figures are for reference only.

LCD	Operation Procedure
	<p>1. On the default page, press  to enter the main menu.</p>
	<p>2. Choose  and press .</p>
<p>Maintenance->The password.</p> 	<p>3. Enter the user name and password by pressing  or , and press .</p> <p>NOTE</p> <ul style="list-style-type: none"> The selectable user names are Advanced User and Special User. The initial password for Advanced User and Special User is 000001. If you forget the password, contact JDA technical support for a dynamic password that is effective only on the current day. Change the password after login. After the authentication is successful, the system keeps the authentication information for 30 seconds. If you exit from the Maintance page and log in again within 30 seconds, no authentication is required.



LCD	Operation Procedure
<pre> Maintenance ----- USB Expansion Data Clear </pre>	4. Choose Data Clear , and press
<pre> Maintenance->Data Clear ----- Clear historical data? ESC:Cancel ↵:Enter </pre>	5. On the displayed page, press .
<pre> Maintenance->Data Clear ----- Clear data finished. </pre> <p style="text-align: right;">↵:Enter</p>	6. Press to complete the operations.

----End

7.2.1 Enabling the USB Guide Function

This topic describes how to enable the USB guide function to implement firmware upgrade, configuration importing, data exporting, and configuration exporting functions with the USB flash drive.

Context

The USB guide functions are described as follows:

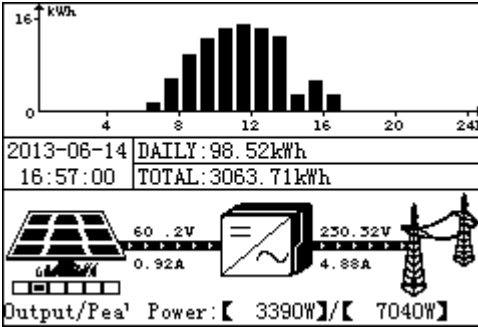

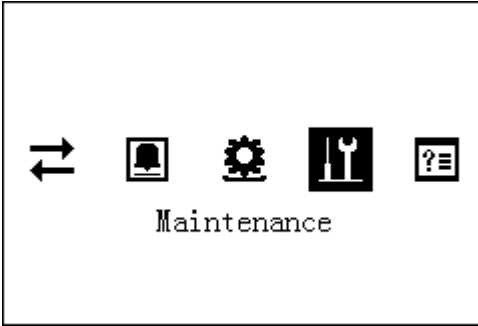


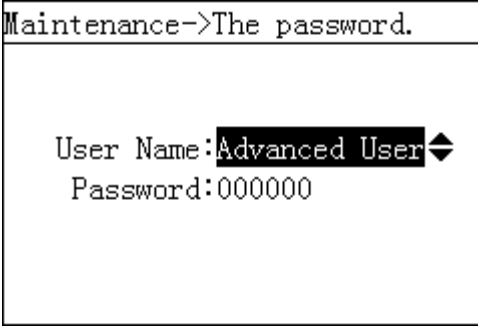



- Firmware upgrade: Upgrade the SUN2000 software.
- Configuration importing: Load the existing configuration file to the SUN2000 and update the configuration parameters in batches (all parameters set on the LCD).
- Data exporting: Download the alarm, performance, log data in the file format to the local computer to facilitate analysis.











- Configuration exporting: Download the configuration parameters in the file format to the local computer.

Procedure

- The following table describes the procedure for enabling the USB guide function. The parameter values in the figures are for reference only.

LCD	Operation Procedure
	<p>1. On the default page, press  to enter the main menu.</p>
	<p>2. Choose  and press .</p>
<p>Maintenance->The password.</p> 	<p>3. Enter the user name and password by pressing  or , and press .</p> <p>NOTE</p> <ul style="list-style-type: none"> • The user name can be set to Advanced User and Special User. The initial password for Advanced User and Special User is <i>000001</i>. If you forget the password, contact JDA technical support for a dynamic password that is effective only on the current day. Change the password after login. • After the authentication is successful, the system keeps the authentication information for 30 seconds. If you exit from the Maintenance page and log in again within 30 seconds, no authentication is required.



LCD	Operation Procedure
<pre> Maintenance USB Expansion Data Clear </pre>	<p>4. Choose USB Expansion, and press .</p> <p>NOTE If no USB flash driver is detected, the LCD displays a message prompting you to insert the USB flash drive.</p>
<pre> Maintenance->USB Expansion Firmware Upgrade Config Import Config Export Data Export </pre>	<p>5. Select a menu by pressing  and , and press .</p> <p>The menus that can be selected include Firmware Upgrade, Config Import, Config Export, and Data Export.</p> <ul style="list-style-type: none"> • If you want to upgrade the firmware, perform step 6 only. • If you want to import the configuration data, perform step 7 only. • If you want to export the configuration data, perform step 8 only. • If you want to export the alarm data, performance data, and system log, perform step 9 only.
<pre> Maintenance->USB Expansion Firmware Upgrade Current :V100R001C00SPC002 Target V :V100R001C00SPC003 ESC:Cancel :Enter </pre>	<p>6. To confirm the Current is correct, press .</p> <p>NOTICE</p> <ul style="list-style-type: none"> • Firmware upgrade is allowed only when the SUN2000 is properly connected to the PV arrays (the PV connection indicator is green). • Before upgrading the firmware, download the upgrade package from http://www.jdauspice.com decompress the package, and copy the files to the root directory of the USB flash drive.
<pre> Maintenance->USB Expansion Config Import Import the config? ESC:Cancel :Enter </pre>	<p>7. Press .</p>



LCD	Operation Procedure
	8. After the configuration data is successfully exported, press .
	9. After the data is successfully exported, press .

----End

7.2.16 Viewing the System Version

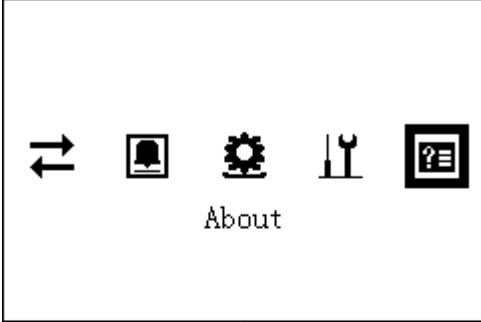


This topic describes how to view the SUN2000 version on the monitoring panel.

Procedure

- The following table describes the procedure for viewing the SUN2000 version. The parameter values in the figures are for reference only.

LCD	Operation Procedure
	1. On the default page, press to enter the main menu.



LCD	Operation Procedure
 <p>← → [Bell] [Gear] [Wrench] [?≡]</p> <p>About</p> <p>↓</p> <hr/> <p>About</p> <p>Type: SUN2000 Model: 20KTL Version: V100R001C00SPC005 SN: 210107136110D4000001</p> <p>www.huawei.com</p>	<p>2. Choose  and press .</p> <p>The version information includes Type, Model, Version, and SN.</p>

----End



8 Maintenance

This topic describes how to perform daily maintenance and troubleshooting to ensure long-term proper operation of the SUN2000.

8.1 Powering Off the SUN2000

When maintaining or replacing the SUN2000, comply with the safety precautions and operation procedure specified in this section.

Context



WARNING

After shutting down the SUN2000, the remaining electricity and heat may cause electrical shocks and body burns. Therefore, operate the SUN2000 five minutes later after the shutdown.

Procedure

- To maintain the SUN2000, perform [Step 1](#) to [Step 3](#). To replace the SUN2000, perform [Step 1](#) to [Step 7](#).
1. On the liquid crystal display (LCD), send a shutdown command.
For details, see [7.2.12 Enabling Manual Power-On and Power-Off](#).
You can also run a shutdown command on the EMS. For details, see the *NetEco1000S V100R001C00 User Manual*.
 2. Disconnect the circuit breaker between the SUN2000 and the power grid.
 3. Set DC SWITCH to OFF.
 4. Disconnect RS485 communications cables.
 5. Disconnect DC input power cables.
For details, see **Follow-up Operation** in [5.3 Installing DC Input Power Cables](#).
 6. Disconnect AC output power cables.
For details, see **Follow-up Operation** in [5.2 Connecting AC Output Power Cables](#).



7. Disconnect PGND cables.

For details, see **Follow-up Operation** in [5.1 Installing PGND Cables](#).

----End

8.2 Daily Maintenance

This section describes the routine maintenance items and intervals for the SUN2000.

Table 8-1 Maintenance list

Check Item	Check Method	Maintenance Interval
System cleaning	Check periodically that the heat sink is free from dust and being covered.	Semiannual or annual
System running status	<ul style="list-style-type: none"> • Check that the SUN2000 is not damaged or deformed. • Check that the running sound of the SUN2000 is normal. • During the running, check that all SUN2000 parameters are correctly set. 	Semiannual
Electrical Connection	<ul style="list-style-type: none"> • Check that cables are secured. • Check that cables are intact and especially the parts touching the metallic surface is not scratched. • Check that the idle RS485 and USB ports are locked by waterproof caps. 	The first inspection is half a year after the initial commissioning. From then on, the interval can be semiannual or annual.
Grounding reliability	Check that ground cables are secured.	The first inspection is half a year after the initial commissioning. From then on, the interval can be semiannual or annual.



NOTE

Before wiping the heat sink, ensure that the DC SWITCH is OFF and the circuit breaker between the SUN2000 and the power grid is disconnected. Wait at least for 5 minutes before wiping the heat sink.

8.3 Common Faults and Troubleshooting Measures

This topic describes the common faults and troubleshooting measures for the SUN2000.



The alarm severity is defined as follows:

- Major: The SUN2000 enters the shutdown mode and disconnects from the power grid to stop generating electricity after a fault occurs.
- Minor: Some components are faulty but the SUN2000 can still generate electricity.
- Warning: The SUN2000 output power decreases due to external factors.

For details, see [Table 8-2](#).

Table 8-2 Rectifying common faults

Alarm ID	Alarm Name	Alarm Severity	Causes	Measures
103	DC Over Voltage	Major	Too many PV modules connected in series lead to excessively high output voltage of PV arrays, making the open circuit voltage of the PV arrays greater than the maximum input voltage of the SUN2000.	Check whether the large number of PV modules connected in series make the open circuit voltage of the PV arrays greater than the maximum input voltage of the SUN2000. If yes, adjust the number of PV arrays connected in series to decrease the output voltage of PV arrays to meet the voltage requirements for the SUN2000. If no, contact JDA technical support. After the adjustment, ensure that the SUN2000 works properly.
106 to 111	String 1-6 Abnormal	Warning	<ul style="list-style-type: none"> • PV arrays are shielded for a long time. • PV arrays deteriorate. 	<ol style="list-style-type: none"> 1. Check whether the output current of a PV array is obviously less than the output current of other PV arrays. 2. If yes, check whether the PV array is shielded. 3. If the PV array is clear and is not shielded, check whether the PV modules are faulty.
120 to 125	String 1-6 Reverse	Warning	The cables between PV arrays are connected reversely during SUN2000 installation.	Check whether the cables between PV arrays are connected reversely. If they are connected reversely, reconnect the cables properly.



Alarm ID	Alarm Name	Alarm Severity	Causes	Measures
200	DC Bus Voltage Fault	Major	<p>Abnormal external conditions trigger the protection for the DC circuit inside the SUN2000. The possible causes are as follows:</p> <ul style="list-style-type: none"> Reason ID = 3 The inverter input is suddenly disconnected, or the PV array to be obstructed result in a sharp change in output power. Reason ID = 9 or 11 The sharp change of grid voltage cause inverter input energy short period of time can not be vented so that the internal voltage increases. Reason ID = 10 The imbalance of grid phase voltage lead to the inverter internal control circuit short keep up with changes and protection. 	<ol style="list-style-type: none"> The SUN2000 detects its external working conditions in real time, and therefore the SUN2000 automatically recovers to the normal operating status after the fault is rectified. If the alarm occurs repeatedly, contact JDA technical support.



Alarm ID	Alarm Name	Alarm Severity	Causes	Measures
202	Invert Module Fault	Major	<p>Abnormal external conditions cause the protection for the inversion circuit inside the SUN2000. The possible causes are as follows:</p> <ul style="list-style-type: none"> Reason ID = 4 The grid voltage sharp reduced or short-circuit, resulting in the inverter output current is too large. Reason ID = 13 The grid voltage sharp reduced or short-circuit, resulting in the inverter internal voltage detection circuit failure. Reason ID = 14 The grid voltage sharp reduced or short-circuit, resulting in instantaneous output current of the inverter is too large. Reason ID = 16 The DC current of grid current exceeds the allowable range. Reason ID = 17 Grid voltage or frequency is abnormal. Reason ID = 20 The inverter output short-circuit led to a sharp increase in output current. 	<p>Reason ID = 4, 13, 14, 16, or 17</p> <ol style="list-style-type: none"> The SUN2000 detects its external working conditions in real time, and therefore the SUN2000 automatically recovers to the normal operating status after the fault is rectified. If the alarm occurs repeatedly, contact JDA technical support. <p>Reason ID = 20</p> <ol style="list-style-type: none"> Check whether the inverter output cable is short-circuit. If the alarm occurs repeatedly, contact JDA technical support.



Alarm ID	Alarm Name	Alarm Severity	Causes	Measures
301	Grid Voltage Abnormal	Major	<p>The voltage of the power grid is beyond the acceptable range. The possible causes are as follows:</p> <ul style="list-style-type: none"> Reason ID = 1 to 6 The grid A, B, or C phase voltage is less than the allowable range. Reason ID = 13 to 18 The grid A, B, or C phase voltage is higher than the allowable range. Reason ID = 26 The grid voltage is higher than the allowable range. Reason ID = 27 or 28 The grid voltage three-phase voltage is difference. Reason ID = 29 Power outage, or the AC line or the AC circuit breaker is disconnected. 	<p>Reason ID = 1 to 6</p> <ol style="list-style-type: none"> If the alarm occurs accidentally, the possible cause is that a power grid is abnormal accidentally. The SUN2000 automatically recovers to the normal operating status after the fault is rectified. If this alarm occurs repeatedly, check whether voltage of the power grid is within the acceptable range. If no, contact the local power operator. If yes, change the power grid overvoltage and undervoltage protection points after obtaining approval from the local power operator. For details about how to change the points, see 7.2.9 Setting Protection Parameters. If the fault persists for a long time, check the AC circuit breaker and output cable of the SUN2000. <p>Reason ID = 13 to 18, or 26</p> <ol style="list-style-type: none"> Check whether the feed grid point voltage is too high, if it is, contact your local power operators. If confirm feed grid point voltage is higher than the permissible scope of consent and the consent of the local power operators, modify the undervoltage protection point. Check whether the grid voltage peak is too high. <p>Reason ID = 27 or 28</p> <ol style="list-style-type: none"> The SUN2000 detects its external working conditions in real time, and therefore the SUN2000 automatically recovers to the normal operating status after the fault is rectified. If the alarm is repeated, affect the normal power generation of the power plant, please contact the local power operators. <p>Reason ID = 29</p> <ol style="list-style-type: none"> Check whether the AC voltage is normal. Check whether the AC line or circuit breaker is disconnected.



Alarm ID	Alarm Name	Alarm Severity	Causes	Measures
305	Frequency Abnormal	Major	The actual frequency of the grid is higher than the local grid standards requirements.	<ol style="list-style-type: none"> 1. If the alarm occurs accidentally, the possible cause is that a power grid is abnormal accidentally. The SUN2000 automatically recovers to the normal operating status after the fault is rectified. 2. If this alarm occurs repeatedly, check whether frequency of the power grid is within the acceptable range. If no, contact the local power operator. If yes, change the power grid overfrequency and underfrequency protection points after obtaining approval from the local power operator. For details about how to change the points, see 7.2.9 Setting Protection Parameters.
313	Low Array Insulation Resistance	Major	<p>The insulation resistance against the ground for PV arrays is less than the minimum value. The possible causes are as follows:</p> <ul style="list-style-type: none"> • The ground cable for the PV arrays is short-circuited. • PV arrays are installed in a long-term moist environment. 	<ol style="list-style-type: none"> 1. Check the insulation resistance against the ground for the outputs of PV arrays. If a short circuit occurs, rectify the fault. 2. If the insulation resistance against the ground is less than the default value in a rainy environment, set the insulation resistance threshold. For details, see 7.2.9 Setting Protection Parameters.
318	Residual Current Abnormal	Major	The insulation resistance against the ground at the input side becomes lower in operating mode, which causes excessively high residual current.	<ol style="list-style-type: none"> 1. If the fault occurs accidentally, the possible cause is that the external circuits are abnormal accidentally. The SUN2000 automatically recovers to the normal operating status after the fault is rectified. 2. If the fault occurs repeatedly and lasts a long time, check the insulation resistance against the ground of PC arrays is excessively low.
321	Cabinet Over-Temp	Major	<ol style="list-style-type: none"> 1. The inverter installation location is not well ventilated. 2. The environment temperature is too high. 3. The internal fan is not working. 	Check whether the operating temperature of the UNS2000 exceeds the upper limit. If yes, improve ventilation to decrease the temperature.



Alarm ID	Alarm Name	Alarm Severity	Causes	Measures
326	Electrical Grounding Fault	Major	<ul style="list-style-type: none"> The neutral wire and ground cable are not connected to the SUN2000. When you ground PV arrays, the isolation transformer is not connected to the SUN2000 at the output side. 	<ol style="list-style-type: none"> Check that the neutral wire and ground cable are properly connected. When PV arrays are grounded, check whether the SUN2000 needs to connect to an isolation transformer at the output side. If yes, connect the transformer to the SUN2000.
400	System Fault	Major	An unrecoverable fault occurs on a circuit inside the SUN2000.	Flip the DC switch on the SUN2000 to OFF, wait for 5 minutes, and flip the DC switch to ON. Check whether the fault is rectified. If no, contact JDA technical support.
502	Internal Communication Fault	Minor	<ul style="list-style-type: none"> The communication circuit of the inverter is disturbed. The communication circuit is damaged. The establishment internal communication address is error. 	<ol style="list-style-type: none"> If the fault is caused by short circuit of the communications circuit inside the SUN2000, the SUN2000 automatically recovers to the normal operating status after the fault is rectified. If the fault cannot be rectified for a long time, contact JDA technical support.
504	Version Mismatch	Minor	During software upgrade of the SUN2000, the version of the software loaded is incorrect.	Check whether you have performed a software upgrade recently. If yes, upgrade the software to the correct version again.
505	Firmware Upgrade Failed	Major	Upgrade is not completed normally.	Upgrade again.
61440	Flash Fault	Minor	<ul style="list-style-type: none"> Lack of Flash space. Bad blocks is in Flash. There is a problem in device. 	<ol style="list-style-type: none"> Replace monitor board. If the monitor board and equipment are one, replace the entire monitor equipment.



NOTE

If you cannot rectify faults with the measures listed in [Table 8-2](#), contact JDA technicalsupport.



9 Inverter-Associated Operations

This topic describes how to remove, pack, and dispose the SUN2000.

9.1 Removing the SUN2000

This topic describes how to remove the SUN2000.

Perform the following operations before removing the SUN2000:

1. Disconnect all cables from the SUN2000, including RS485 communications cables, DC input power cables, AC output power cables, and protection ground (PGND) cables.
For details, see [8.1 Powering Off the SUN2000](#).
2. **Optional:** Open the anti-theft lock at the bottom of the SUN2000.
3. Remove the SUN2000 from the rear panel.
4. Remove the rear panel.

9.2 Packing the SUN2000

This topic describes how to pack the SUN2000.

- If the original packing materials are available, put the SUN2000 inside them and then seal them by using adhesive tape.
- If the original packing materials are not available, put the SUN2000 inside a suitable hard carton and seal them properly.

9.3 Disposing the SUN2000

This topic describes how to dispose the SUN2000.

If the SUN2000 service life expires, dispose the SUN2000 according to the local rules about disposing electrical equipment waste, or return the SUN2000 to JDA. Customers pay the expenses for disposing the SUN2000.



10 Technical Specifications

This topic lists the technical specifications for all SUN2000 models.

Efficiency

Technical Specifications	SUN2000-8KTL	SUN2000-10KTL	SUN2000-12KTL	SUN2000-15KTL	SUN2000-17KTL	SUN2000-20KTL	SUN2000-23KTL	SUN2000-28KTL
Max. efficiency	98.50%			98.60%			98.70%	
European efficiency	98.00%			98.30%			98.40%	

Input

Technical Specifications	SUN2000-8KTL	SUN2000-10KTL	SUN2000-12KTL	SUN2000-15KTL	SUN2000-17KTL	SUN2000-20KTL	SUN2000-23KTL	SUN2000-28KTL
Max DC power ($\cos\phi=1$)	9,100 W	11,400 W	13,700 W	17,100 W	19,200 W	22,500 W	23,600 W	28,200 W
Max. input voltage	1000 V							
Max. input current per MPPT	18 A							
Max. short circuit current per MPPT	25 A							
Max. input current (3 MPPT)	54 A							
Min. operating voltage	200 V							



Technical Specifications	SUN2000-8KTL	SUN2000-10KTL	SUN2000-12KTL	SUN2000-15KTL	SUN2000-17KTL	SUN2000-20KTL	SUN2000-23KTL	SUN2000-28KTL
MPP voltage range	320 V-800 V		380 V-800 V	400 V-800 V		480 V-800 V		
Rated input voltage	620 V							
Max. number of inputs	4			6				
Number of MPP trackers	2 ^a			3 ^b				

a: 2 MPPTs can work independently or work in parallel.

b: 3 MPPTs can work independently, or work in parallel, or any 2 of 3 MPPTs work in parallel.

Output

Technical Specifications	SUN2000-8KTL	SUN2000-10KTL	SUN2000-12KTL	SUN2000-15KTL	SUN2000-17KTL	SUN2000-20KTL	SUN2000-23KTL	SUN2000-28KTL	
Rated power(230 V, 50Hz)	8,000 VA	10,000 VA	12,000 VA	15,000 VA	17,000 VA	20,000 VA	23,000 VA	27,500 VA	
Max. AC output power (cosφ=1)	8,800 W	11,000 W	13,200 W	16,500 W	18,700 W	22,000 W	-	-	
Rated output voltage	220 V - 230 V / 380 V - 400 V, 3W + N + PE							277 V / 480 V, 3W + PE	
AC power frequency	50 Hz/60 Hz								
Max. output current	12.8 A	16 A	19.2 A	24 A	27.2 A	32 A	33.5 A	33.5 A	
Power factor	0.8 overexcited ... 0.8 underexcited								
Max. total harmonic distortion	< 3%								
AC connected Inrush current (Peak / Duration)	33 A / 2 ms								
Max. output short current (Peak / Duration)	400 A / 110 ms								



Protection

Technical Specifications	SU N2000 -8KTL	SUN2000 -10KTL	SUN2000 -12KTL	SUN2000 -15KTL	SUN2000 -17KTL	SUN2000 -20KTL	SUN2000 -23KTL	SUN2000 -28KTL
Input-side disconnection device	Yes							
Anti-islanding protection	Yes							
AC over current protection	Yes							
DC reversepolarity protection	Yes							
PV array string fault monitoring	Yes							
DC surge arresters	Class II							
AC surge arresters	Class III							
Insulation monitoring	Yes							
Residual current detection	Yes							

Display and Communication

Technical Specifications	SUN2000 -8KTL	SUN2000 -10KTL	SUN2000 -12KTL	SUN2000 -15KTL	SUN2000 -17KTL	SUN2000 -20KTL	SUN2000 -23KTL	SUN2000 -28KTL
Display	Graphical LCD							
RS485	Yes							
USB	Yes							

General Data

Technical Specifications	SUN2000 -8KTL	SUN2000 -10KTL	SUN2000 -12KTL	SUN2000 -15KTL	SUN2000 -17KTL	SUN2000 -20KTL	SU N2000 -23KTL	SUN2000 -28KTL
--------------------------	------------------	-------------------	-------------------	-------------------	-------------------	-------------------	--------------------	-------------------



Technical Specifications	SUN2000-8KTL	SUN2000-10KTL	SUN2000-12KTL	SUN2000-15KTL	SUN2000-17KTL	SUN2000-20KTL	SUN2000-23KTL	SUN2000-28KTL
Dimensions (W x H x D)	520 mm x 610 mm x 255 mm (20.5 in. x 24.0 in. x 10.0 in.)							
Weight	40 kg			48 kg				
Operating temperature range	-25°C to +60°C (-13°F to +140°F)							
Cooling	Natural convection							
Operating altitude	3000 m (9842.4 ft.)							
Relative humidity (non-condensing)	0%–100%							
DC connector	Amphenol H4							
AC connector	Amphenol C16/3							
Degree of protection	IP65							
Protective Class	Class I							
Degree of pollution	III							
Self-consumption at night	< 1 W							
Topology	Transformerless							
Noise	≤ 29 dB							
Warranty	5 years							

Standards Compliance

Technical Specifications	SUN2000-8KTL	SUN2000-10KTL	SUN2000-12KTL	SUN2000-15KTL	SUN2000-17KTL	SUN2000-20KTL	SUN2000-23KTL	SUN2000-28KTL
Safety/EMC	EN/IEC62109-1, EN/IEC62109-2, EN61000-6-2, EN61000-6-3, EN61000-3-2, EN61000-3-3, EN61000-3-11, EN61000-3-12							
Grid code	VDE-AR-N4105, VDE0126-1-1, BDEW 2008, CEI 0-21, CEI0-16, G59/2, G83/2, AS4777, CGC/GF004:2011, IEC61727, IEC62116, EN50438, MEA 2013, PEA 2013							



11 Quality Assurance

Warranty

During the warranty period, the user should provide the invoice and date. The signs on the products should be clear. Otherwise, JDA will not be liable for the quality assurance. The warranty period of this product is 60 months after it is unpacked and accepted. The start time must be within 30 days after the delivery date. The contract prevails if it specifies the warranty.

Quality Assurance Regulations

- JDA maintains or replaces the equipment freely if the equipment becomes faulty within the warranty period.
- Return the faulty or damaged equipment to JDA.

Disclaimer

- Damage caused during transportation.
- Incorrect installation.
- Misoperation.
- Damage caused by abnormal natural environments.
- Operation under severe environments which are not specified in this document.
- Unauthorized product changes and software code modification.
- Usage under installation and operating environments which are not specified in related international specifications.
- Ignorance of the safety precautions and regulations specified in this document.



A

Abbreviation

A	
ACDU	AC Distribution Module
E	Element Management System
EMI	Electromagnetic Interference
EMS	
L	
LCD	Liquid Crystal Display
LED	Light Emitting Diode
M	
MMP	Maximum Power Point
MPPT	Maximum Power Point Tracking
P	
PE	Protective Earthing
PGND	Protection Ground
PV	Photovoltaic
S	
SPD	Surge Protection Device



B Power Grid Standard Codes

This topic describes how to set the power grid standard code based on the standards of the country or region where the power station locates.

Table B-1 Power Grid Standard Codes

No.	Power grid standardcode	Description
1	VDE-AR-N-4105	Germany low-voltage power grid
2	CGC/GF004:2011	China golden sun low-voltage power grid
3	UTE C 15-712-1(A)	France continent
4	UTE C 15-712-1(B)	France island 50 Hz
5	UTE C 15-712-1(C)	France island 60 Hz
6	VDE 0126-1-1-BU	Bulgaria
7	BDEW-MV	Germany medium-voltage power grid
8	G59-England	England 230 V power grid (I>16 A)
9	G59-Scotland	Scotland 240 V power grid (I>16 A)
10	G83-England	England 230 V power grid (I<16 A)
11	G83-Scotland	Scotland 240 V power grid (I<16 A)
12	CEI0-21	Italy low-voltage power grid
13	IEC61727	India
14	CEI0-16	Italy medium-voltage power grid
15	CHINA-MV480	China medium-voltage power grid (no neutral wires for 28 kW systems)
16	TAI-PEA	Thailand 220 V
17	TAI-MEA	Thailand 230 V
18	BDEW-MV480	Germany medium-voltage power grid (no neutral wires for 28 kW systems)



No.	Power grid standardcode	Description
19	G59-MV	UK 480 V medium-voltage grid-tied (I>16 A)
20	IEC61727-MV	IEC61727 medium-voltage grid-tied
21	UTE C 15-712-1-MV	France 480 V medium-voltage power grid
22	TAI-PEA-MV	Thailand medium-voltage grid-tied PEA
23	TAI-MEA-MV	Thailand medium-voltage grid-tied MEA
24	EN 50438-DK	Denmark medium-voltage grid-tied
25	Japan (50 Hz)	Japan 50 Hz
26	Japan (60 Hz)	Japan 60 Hz
27	EN50438-Turkey-MV	Turkey medium-voltage power grid
28	EN50439-Turkey	Turkey low-voltage power grid
29	C10/11	Belgium
30	C10/11-MV	Belgium medium-voltage power grid
31	EN50438Y2007-NL	Netherlands